



# FLAT DISPLAY TECHNOLOGY

8.0" Chassis Monitor

Model Number: LCM0804xx



This product is RoHS compliant

**SPEC No.: SAS-0907003**

**Version: 0.0**

**Issue Date: July 8 2009**



## 1. Introduction:

### 1.1 About the Product

The LCM0804xx 8" Chassis Monitor series are rugged, high performance Industrial LCD Monitors, designed for commercial and industrial applications, such as kiosks, arcade games, ATM Machines, aviation simulators, military, medical, marine, security, industrial equipment, and instrumentation equipment. This product can provide high brightness and contrast to achieve better viewing effect.

### 1.2 Features

- 8.0 inch SVGA Active Matrix Color TFT LCD Monitor
- High Contrast 900:1 Typical
- Recommend resolution:800x600(SVGA)
- OSD controls: Allow on-screen adjustments of Brightness, Contrast, RGB Auto Color Balance, H-Position, V-position
- Multi system Video Input
- Signal loss backlight will be off / signal feed again backlight will be on
- Quick and easy integrations for Client solutions
- Universal AC Power input and auto detection video system.
- PMMA ( Poly Methyl MethAcrylate ) protection (Hard Coating + Anti Glare) (option)
- Touch screen (option)
- Sunlight readable (option)

## 2. Contents

Contents Index	Page
<b>1. Introduction</b> .....	1
1.1 About the product	1
1.2 Features	1
<b>2. Contents</b> .....	2
<b>3. Specifications</b> .....	3
<b>4. Ordering Information</b> .....	4
<b>5. VGA Input Format</b> .....	5
<b>6. Mechanical Drawing</b> .....	6-11
6.1 LCM080403-000R	6
6.2 LCM08045U-000R	7
6.3 LCM08045R-000R	8
6.4 LCM080403-010R	9
6.5 LCM08045U-010R	10
6.6 LCM08045R-010R	11
<b>7. Packing List</b> .....	12
<b>8. Installing the Monitor</b> .....	13
8.1 Power Cable Connection	13
8.2 VGA Signal Cable Connection	13
8.3 Video / S-Video Cable Connection	13
8.4 Switch On The Power	13
<b>9. OSD Control</b> .....	14-16
9.1 Menu Operation	14-15
9.2 Operations	16
<b>10. Trouble Shooting</b> .....	17

### 3. Specifications

Parameter	Specifications	Unit	Remark
Model Name	LCM0804xx		
Screen Size	8.0" (diagonal)	inch	
Display Format	800 x (R.G.B) x 600	dot	
TFT-LCD Active Area	162 (H) x 121.5 (V)	mm	
Pixel Pitch	0.2025 (H) x 0.2025 (V)	mm	
Contrast Ratio	900:1(Typ.)		
Brightness	400(Typ.)	Cd/m <sup>2</sup>	
Viewing Angle	-80~80(H); -70~60(V)(Typ.)	deg	
	Video and S-video /		
Input/Output Interface	D-Sub 15 pin female for VGA / USB or RS-232 (DB9 Female) for Touch Screen Driver (Option)		
Power Source	100-240V <sub>AC</sub> 50-60Hz, Universal / +12V <sub>DC</sub> @ 3A		
Power Consumption	TBD		
Touch Screen Controller	5 wire Resistive Driver USB/ RS232 (Option)		
Operating Temperature	-10~60	°C	
Storage Temperature	-20~70	°C	
LED Life Time	30000(Typ.)	hr	

FLAT DISPLAY TECHNOLOGY

■ LCM0804xx V0.0 

## 4. Ordering Information

Parameter	LCM080403-000R	LCM08045U-000R	LCM08045R-000R	Unit
CVBS	1	1	1	
S-Video	1	1	1	
VGA	SVGA (800x600)	SVGA (800x600)	SVGA (800x600)	
Touch Panel Type	-	5W Resistive	5W Resistive	
Touch Screen Interface	-	USB	RS-232	
PMMA (Hard Coating +Anti Clare)	⊙	-	-	
Outline Dimension	225 (W) x 161(H) x32.6 (D)	225 (W) x 161(H) x32.6 (D)	225 (W) x 161(H) x32.6 (D)	mm
Weight (Include Accessory)	1.2 (2)	1.3 (2.1)	1.3 (2.1)	Kg
Frame Material (Color)	Iron (Black)	Iron (Black)	Iron (Black)	

Note: Weight  $\pm$  10%

Parameter	LCM080403-010R	LCM08045U-010R	LCM08045R-010R	Unit
CVBS	-	-	-	
S-Video	-	-	-	
VGA	SVGA (800x600)	SVGA (800x600)	SVGA (800x600)	
Touch Panel Type	-	5W Resistive	5W Resistive	
Touch Screen Interface	-	USB	RS-232	
PMMA (Hard Coating +Anti Clare)	⊙	-	-	
Outline Dimension	225 (W) x 161(H) x32.6 (D)	225 (W) x 161(H) x32.6 (D)	225 (W) x 161(H) x32.6 (D)	mm
Weight (Include Accessory)	1.1 (1.9)	1.2 (2)	1.2 (2)	Kg
Frame Material (Color)	Iron (Black)	Iron (Black)	Iron (Black)	

Note: Weight  $\pm$  10%

FLAT DISPLAY TECHNOLOGY

■ LCM0804xx V0.0 

## 5. VGA Input Format

	Mode	Family	Resolution	H-Freq. (KHz)		V-Freq. (KHz)	
1	Mode 1	PC	720x350	31.47	(+)	70.1	(-)
2	Mode 2	PC	720x400	31.47	(-)	70.1	(+)
3	Mode 3	PC	640x480	31.47	(-)	59.9	(-)
4	Mode 4	VESA	640x480	37.86	(-)	72.8	(-)
5	Mode 5	VESA	640x480	37.50	(-)	75.0	(-)
6	Mode 6	VESA	800x600	37.88	(+)	60.3	(+)
7	Mode 7	VESA	800x600	48.08	(+)	72.2	(+)
8	Mode 8	VESA	800x600	46.88	(+)	75.0	(+)
9	Mode 9	VESA	1024x768	48.36	(-)	60.0	(-)
10	Mode 10	VESA	1024x768	56.48	(-)	70.1	(-)
11	Mode 11	VESA	1024x768	60.02	(+)	75.0	(+)
12	Mode 12	VESA	1280x1024	63.98	(+)	60.0	(+)

FLAT DISPLAY TECHNOLOGY

# 6. Mechanical Drawing

## 6.1 LCM080403-000R

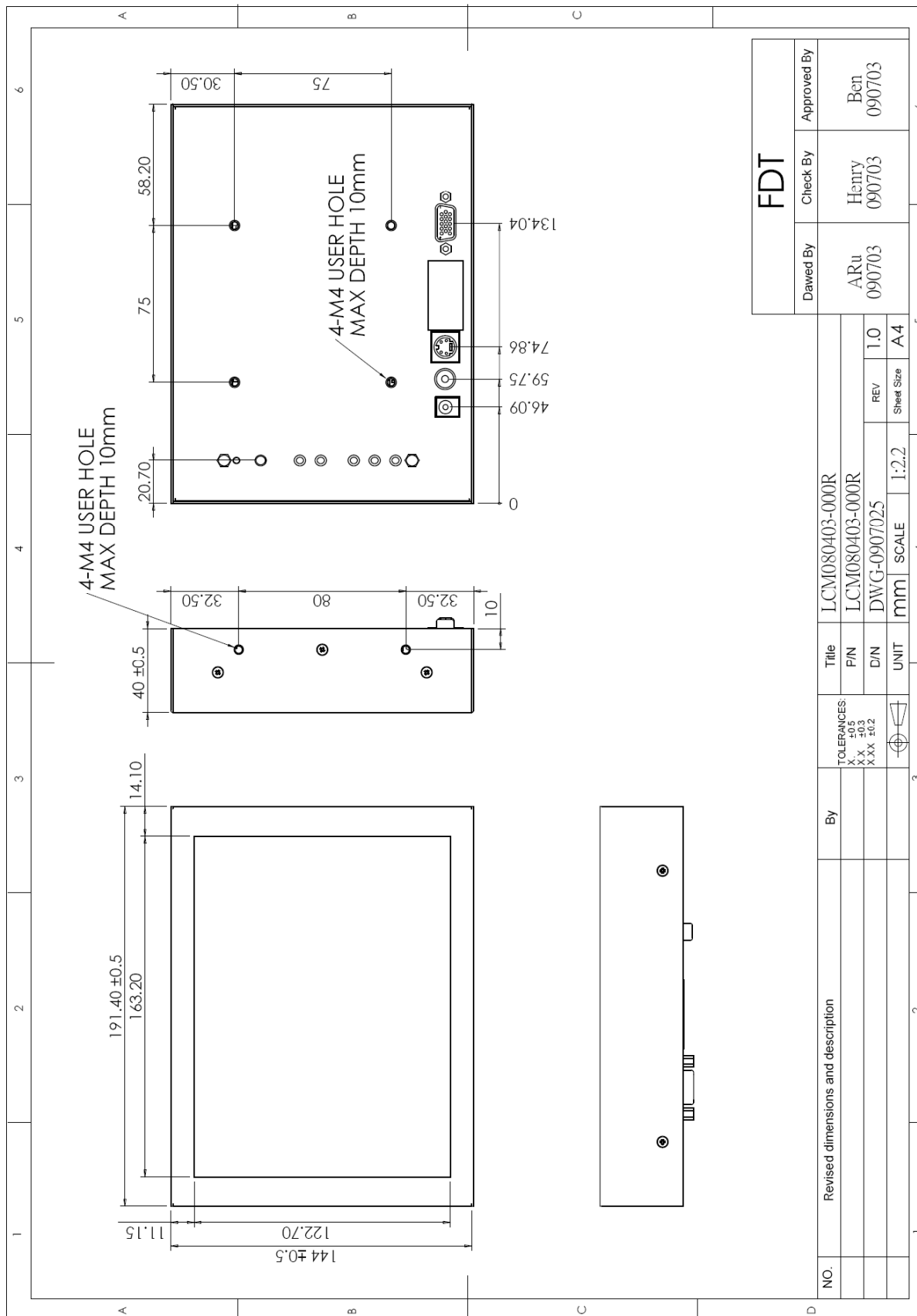

<b>FDT</b>		
Drawn By	Check By	Approved By
ARu 090703	Henry 090703	Bcn 090703

NO.	Revised dimensions and description	By	Title	LCM080403-000R
			P/N	LCM080403-000R
			D/N	DWG-0907025
			UNIT	mm
			SCALE	1:2.2
			REV	1.0
			Sheet Size	A4

FLAT DISPLAY TECHNOLOGY

■ LCM0804xx V0.0 

Copyright 2009 FDT E-mail- fdt@fdt.com.tw  
Tel: 886-4-22619577 Fax: 886-4-22623978

add: NO.85, FuHsing Road, Sec.1, South Dist., TaiChung City 402 TAIWAN R.O.C

This technical specification is subject to change without notice

6.2 LCM08045U-000R

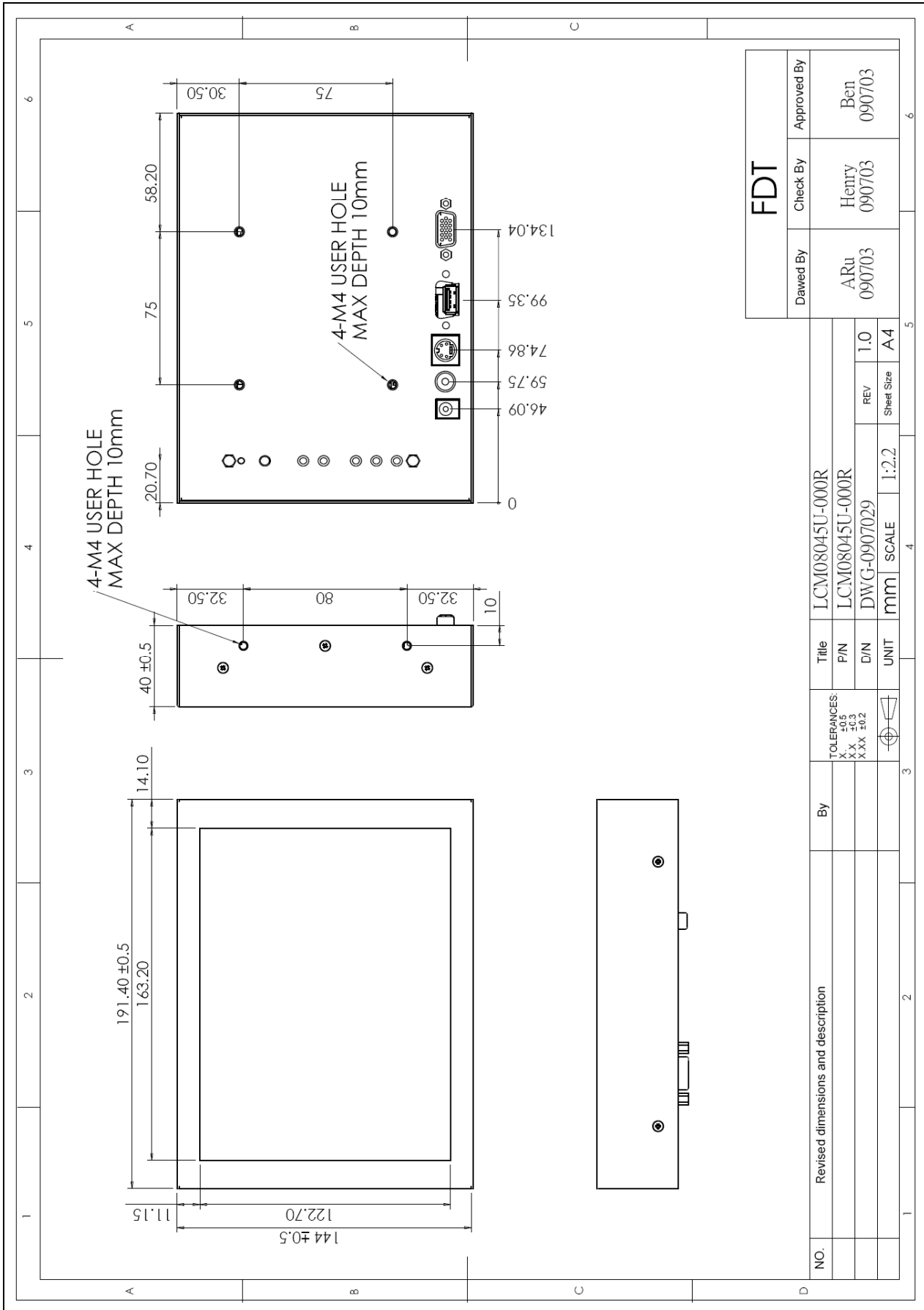

**6.3 LCM08045R-000R**

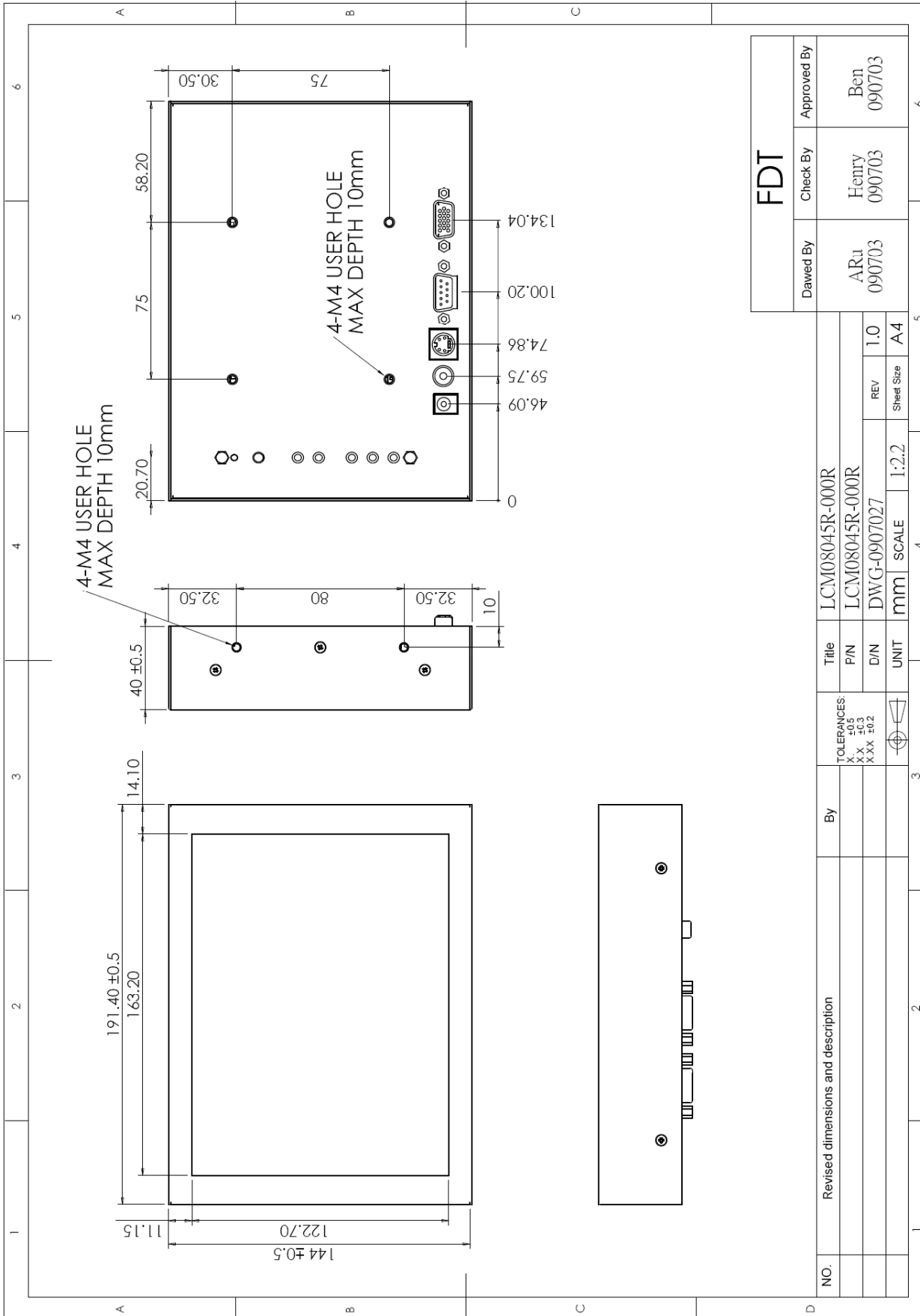

<b>FDT</b>		
Dawed By	Check By	Approved By
ARu 090703	Henry 090703	Ben 090703

NO.	Revised dimensions and description	By	Title	LCM08045R-000R
			P/N	LCM08045R-000R
			D/N	DWG-0907027
			UNIT	mm
TOLERANCES:			SCALE	1:2.2
X	±0.5		REV	1.0
X.X	±0.3		Sheet Size	A4
X.XX	±0.2			

FLAT DISPLAY TECHNOLOGY

■ LCM0804xx V0.0





6.6 LCM08045R-010R

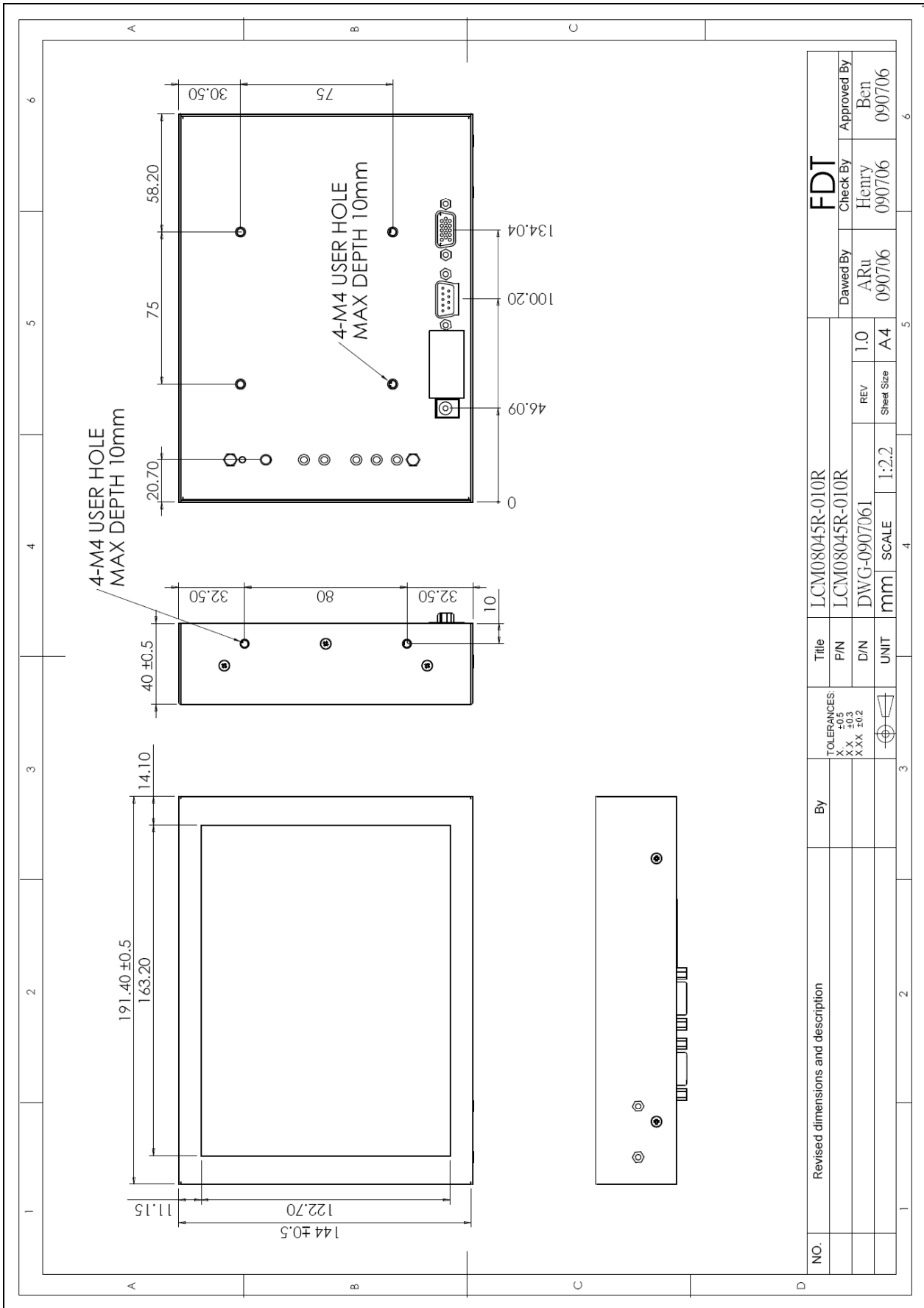

NO.	Revised dimensions and description	By	TOLERANCES: X ±0.5 XX ±0.3 XXX ±0.2	Title	LCM08045R-010R	FDT	
			⌀	P/N	LCM08045R-010R	Drewn By	ARu
				DIN	DWG-0907061	Check By	Henry
				UNIT	mm	REV	1.0
				SCALE	1:2.2	Sheet Size	A4
						Approved By	Ben
							090706
							090706

## 7. Packing List

Before you begin installing the Chassis Monitor, please make sure that the following materials have been shipped:



- A. AC to DC Adapter (100-240VAC 50-60Hz to +12VDC @ 3A)
- B. Power Cord (Plug Type B for USA)
- C. Video Cable (LCM0804xx-000R Only)
- D. S-Video Cable (LCM0804xx-000R Only)
- E. VGA Cable
- F. USB Cable LCM08045U Only)
- G. RS-232 Cable (LCM08045R Only)
- H. Touch Screen Driver CD Disk (LCM08045U & LCM08045R Only) / User Manual
- I. M4x8 Screw x 4 pcs

If any of these items are missing or damaged, contact your distributor or sales representative immediately.

## 8. Installing the Monitor

### 8.1 Power cable connection:

Connect the power cord to the AC outlet, and connect the power to the monitor through the AC/DC adapter.

### 8.2 VGA signal cable connection:

Plug one end of the 15-pin signal cable to the VGA connector at the rear of the PC system and the other end to the Chassis monitor.

Secure the connectors with the screws on the cable connector at both ends.

### 8.3 Video / S-Video Cable connection:

If required, connect Video / S-Video Cable from the Chassis Monitor to the DVD or CCD Camera.

### 8.4 Switch on the power:

Switch on the power switch on the rear cover of the Chassis Monitor.

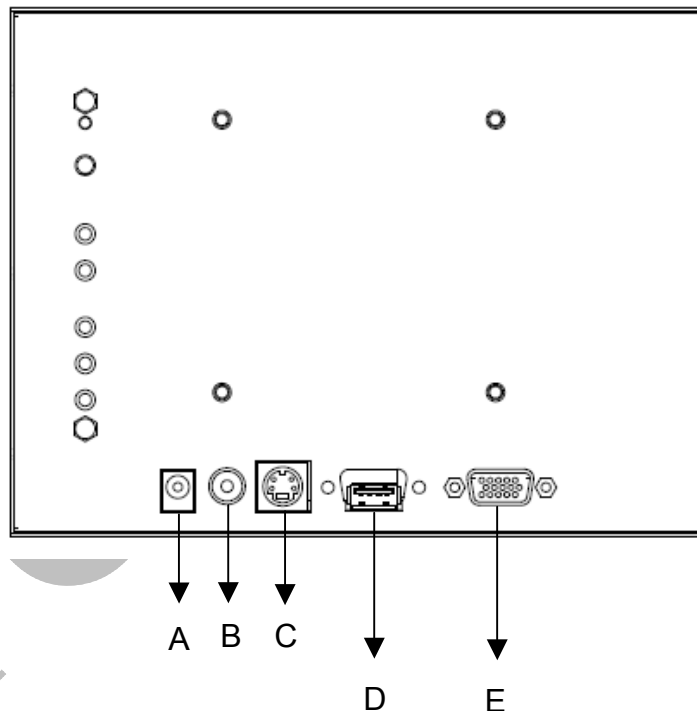

- A. DC-In (+12V<sub>DC</sub> The DC jack core is positive)
- B. Video (CVBS) In
- C. S-Video (Y/C Video) In
- D. Touch USB or RS232 Interface
- E. VGA D-sub 15 (Female)

## 9. Key Function by OSD

### 9.1 Menu Operation

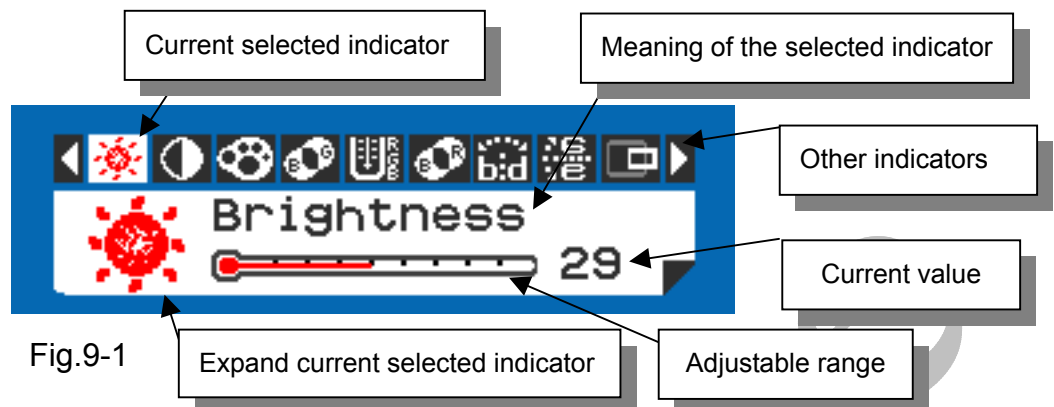
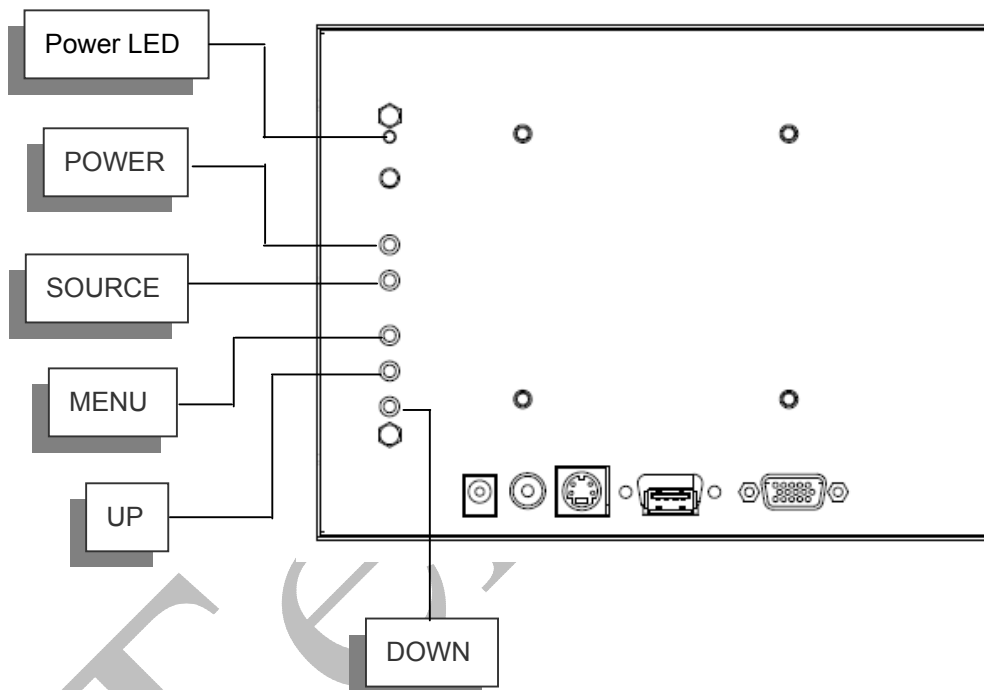

Fig.9-1



#### Operations of key board :

1. To navigate the menu, press [MENU]. (Fig.9-1)
2. The indicator lighting up in white color is the selected adjustment item.
3. To Next Item of the menu, press [MENU] again.
4. The operations below are only available when "Menu" is started.
5. Press [UP] / [DOWN] to adjust the value of the selected item.

## Overview of the menu :

Firmware must be  $\geq$  VER 0.25

















Indicator	Meaning	Adjustable range	For	Remark
	Brightness	0 ~ 64	AV / S-Video / VGA	Adjust-Bar
	Contrast	0 ~ 64	AV / S-Video / VGA	Adjust-Bar
	Color	0 ~ 64	AV / S-Video	Adjust-Bar
	Tint	0 ~ 32	AV / S-Video	Adjust-Bar
	Sharpness	0 ~ 16	AV / S-Video	Adjust-Bar
	Color Tone	Normal / Warm / Cool	AV / S-Video / VGA	
	Mirror	OFF / ON	AV / S-Video / VGA	
	Flip	OFF / ON	AV / S-Video / VGA	
	H-Position	-25 ~ +25	VGA	Balance-Bar
	V-Position	-10 ~ +10	VGA	Balance-Bar
	Auto		VGA	
	Scan	Over Scan / Under Scan	AV / S-Video	
	Information		AV / S-Video / VGA	Fig.9-2
	Setup		AV / S-Video / VGA	Fig.9-3
	Factory Set		AV / S-Video / VGA	
	Exit		AV / S-Video / VGA	

Fig.9-2



Setup Menu :

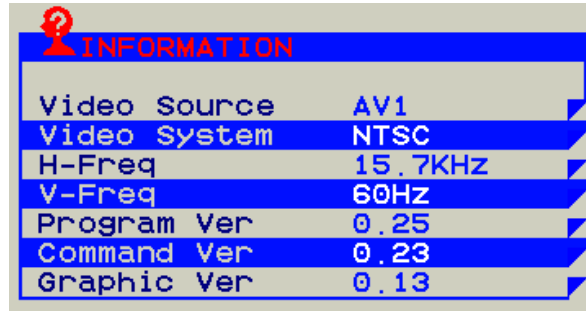

Fig.9-3

Indicator	Meaning	Adjustable range	Function	Remark
	Show Status	ON / OFF	Show screen status.	ON: Show OFF: Hidden
	Blue Screen	ON / OFF	If loss signal will put on the blue or black screen.	ON: Blue OFF: Black
	Auto Power On	ON / OFF	Power input module will be auto turn on.	ON: Auto OFF: Manual
	Auto Sleep	OFF / 3s / 5s / 15s / 30s	If signal loss over setting times will be power off.	ON: Auto OFF: Normal
	Detect Source	ON / OFF	Auto detection which source in exist.	ON: Auto OFF: Normal
	Return			

Note : Priority : Auto Sleep > Auto Power On

Note : VGA Only don't have Detect Source function.

**9.2 Operations**

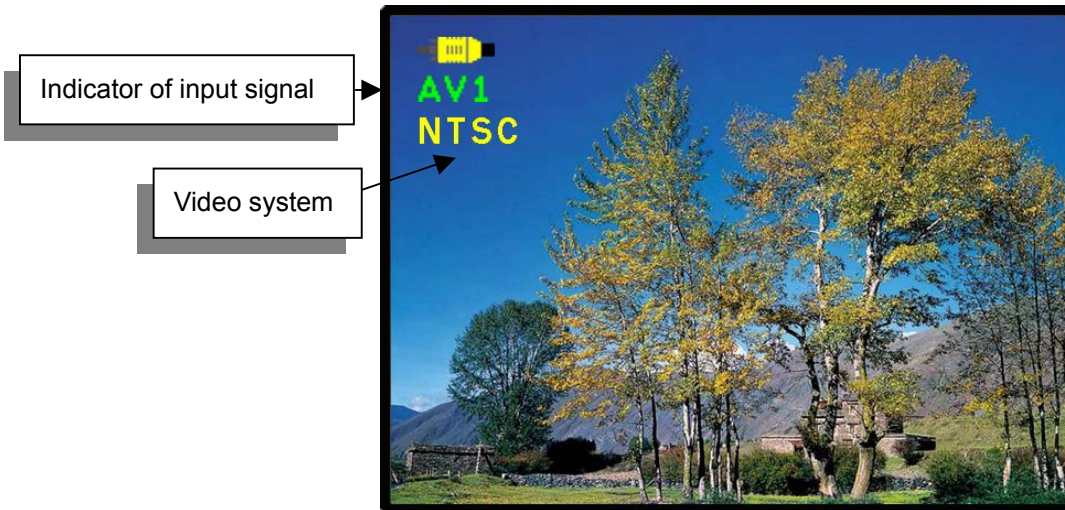





Fig.9-4

[Power] : Monitor power on / off

[Source] : Input signal switch

**Overview of input signals :**

Indicator	Input signal	Interface	Video system
	AV1	Composite	NTSC / PAL / SECAM
	S-Video1	Y/C	NTSC / PAL / SECAM
	VGA	Analog RGB	640x480_60 / 800x600_60 / 1024x768_60 / 1280x1024_60

## 10. Trouble Shooting

If experiencing trouble with the monitor, or it fails to operate correctly, please refer to the following instructions before calling for repairs.

Condition	Check Point
1. The picture does not appear	<ul style="list-style-type: none"><li>● Check to see that all the I/O and power cables is firmly seated in the socket.</li><li>● Check the Power LED is Lighting When the monitor was turned ON.</li><li>● Check if the brightness control is at the appropriate position, not at the minimum.</li></ul>
2. The screen is not synchronized	<ul style="list-style-type: none"><li>● Check if the I/O signal cable is firmly seated in the socket.</li><li>● Check if the output level matches the input level.</li><li>● Make sure the signal timings of the computer system are within the specification of the monitor.</li></ul>
3. The position of the screen is not in the center	<ul style="list-style-type: none"><li>● Adjust the H-position, and V-position, or perform the auto adjustment Or Factory Set.</li></ul>
4. The screen is too bright (too dark).	<ul style="list-style-type: none"><li>● Check if the brightness or contrast control is at the appropriate position, not at the Maximum (Minimum).</li></ul>
5. The Screen is shaking or waving	<ul style="list-style-type: none"><li>● Press the Auto adjustment control to adjust. Moving all objects which emit a magnetic field such as motor or transformer, away from the monitor. Check if the specific voltage is applied.</li><li>● Check if the signal timing of the computer system is within the specification of monitor.</li></ul>

If you are unable to correct the fault by using this chart, stop using your monitor and contact us.