



FLAT DISPLAY TECHNOLOGY

15" Digital TFT-LCD Module
Model Number: SR150GXExA-FDR



This product is RoHS compliant

SPEC No.: SAS-0906001

Version: 0.0

Issue Date: September 18, 2009

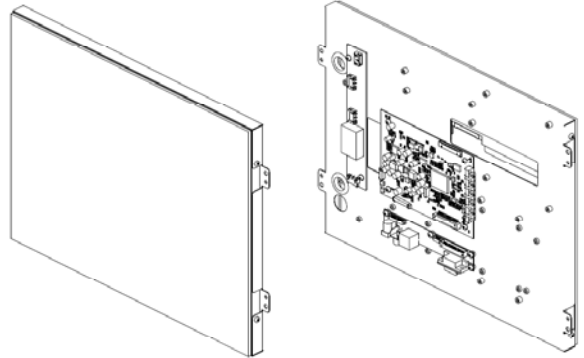

1. Introduction:

1.1 About the Product

The SR150GXExA-FDR 15.0" TFT-LCD Module series are rugged, high performance Industrial LCD Monitors, designed for commercial and industrial applications, such as kiosks, arcade games, ATM Machines, aviation simulators, military, medical, marine, security, industrial equipment, and instrumentation equipment. This product can provide high brightness and contrast to achieve better viewing effect.

1.2 Features

- 15.0 inch XGA Color TFT LCD Monitor.
- High Contrast 700:1 Typical
- Recommend resolution: 1024(R.G.B)×768(XGA).
- Sunlight readable.
- OSD controls: Allow on-screen adjustments of Brightness, Contrast, RGB Auto Color Balance, H-Position, V-position
- Multi system Video Input and auto detection video system.
- Touch screen function of USB or RS232 (option)
- Earphone Output & Ext_ Line-in (option)
- Support DVB-T System (option)
- Light sense for backlight brightness control (option)
- Audio Input (option)
- Max 5W Speaker Output (option)
- Media Player Function (option)

2. Contents

Contents Index	Page
1. Introduction.....	1
1.1 About the product	1
1.2 Features	1
2. Contents.....	2
3. Specifications.....	3
4. Ordering Information.....	4
5. Support Display Resolution Mode.....	5
6. Mechanical Drawing.....	6-7
6.1 SR150GXETA-FDR	6
6.2 SR150GXECA-FDR	7
7. Packing List.....	8
8. Installing the Monitor.....	9
8.1 Power Cable Connection	9
8.2 VGA Signal Cable Connection	9
8.3 Video / S-Video Cable Connection	9
8.4 Switch On The Power	9
9. OSD Control.....	10-13
9.1 Menu Operation	10-12
9.2 Operations	13
10. Trouble Shooting.....	14

3. Specifications

Parameter	Specifications	Unit	Remark
Model Name	SR150GXEA-FDR		
Screen Size	15.0" (diagonal)	inch	
Display Format	1024 x (R.G.B) x 768	dot	
TFT-LCD Active Area	304.128 (H) x 228.096 (V)	mm	
Pixel Pitch	0.297 (H) x 0.297 (V)	mm	
Contrast Ratio	700:1(Typ.)		
Brightness	450(Typ.)	Cd/m ²	
Viewing Angle	-80~80(H); -80~80(V)(Typ.)	deg	
Input/Output Interface	Video and S-video / D-Sub 15 pin female for VGA / USB or RS-232 (DB9 Female) for Touch Screen Driver (Option)		
Power Source	100-240V _{AC} 50-60Hz, Universal / +12V _{DC} @ 3A		
Power Consumption	< 22W		
Touch Screen Controller	USB/ RS232 (Option)		
Operating Temperature	-20~70 (With Touch -10~+70)	°C	
Storage Temperature	-20~80	°C	
Lamp Life Time	50000	Hr	8.0mA

FLAT DISPLAY TECHNOLOGY

■ SR150GXEA-FDR V0.0 

4. Ordering Information

Parameter	SR150GXETA-FDR	SR150GXECA-FDR	Unit
CVBS	1	-	
S-Video	1	-	
VGA	XGA (1024x768)	XGA (1024x768)	
Touch Panel Type	-	-	
Touch Screen Interface	-	-	
Outline Dimension	346.7(W) x 255.3(H) x 31(D)	346.7(W) x 255.3(H) x 33.3(D)	mm
Speaker OUT / MAX 5W	-	-	
Earphone/Line-in	-	-	
Outdoor Treatment	OB+AR_Glass	OB+AR_Glass	Note
AC to DC Adapter 12V/3A (LASTD12030-FDR)	⊙	⊙	
Power Cord (LAACD18000-FDR)	⊙	⊙	
Video Cable (LAVDO18000-FDR)	⊙	-	
S-Video Cable (LASVO18000-FDR)	⊙	-	
VGA Cable (LAVGA16000-FDR)	⊙	⊙	
USB Cable (LAUSB18000-FDR)	-	-	
RS-232 Cable (LARS218000-FDR)	-	-	
Touch Screen Driver CD Disk	-	-	
Bracket	⊙	⊙	
Weight (Include Accessory)	2.4 (3.2) ± 15%	2.4 (3.2) ± 15%	Kg

Note: OB = Optical Bonding

AR_Glass = AR Strengthened Glass

FLAT DISPLAY TECHNOLOGY

■ SR150GXEXA-FDR V0.0 

5. Support Display Resolution Mode

	Mode	Family	Resolution	H-Freq. (KHz)		V-Freq. (KHz)	
1	Mode 1	PC	720x350	31.47	(+)	70.1	(-)
2	Mode 2	PC	720x400	31.47	(-)	70.1	(+)
3	Mode 3	PC	640x480	31.47	(-)	59.9	(-)
4	Mode 4	VESA	640x480	37.86	(-)	72.8	(-)
5	Mode 5	VESA	640x480	37.50	(-)	75.0	(-)
6	Mode 6	VESA	800x600	35.16	(+)	56.3	(+)
7	Mode 7	VESA	800x600	37.88	(+)	60.3	(+)
8	Mode 8	VESA	800x600	48.08	(+)	72.2	(+)
9	Mode 9	VESA	800x600	46.88	(+)	75.0	(+)
10	Mode 10	VESA	1024x768	48.36	(-)	60.0	(-)
11	Mode 11	VESA	1024x768	56.48	(-)	70.1	(-)
12	Mode 12	VESA	1024x768	60.02	(+)	75.0	(+)
13	Mode 13	VESA	1280x1024	63.98	(+)	60.0	(+)

※Recommend customer to use VGA (1024x768) resolution.

6. Mechanical Drawing

6.1 SR150GXETA-FDR

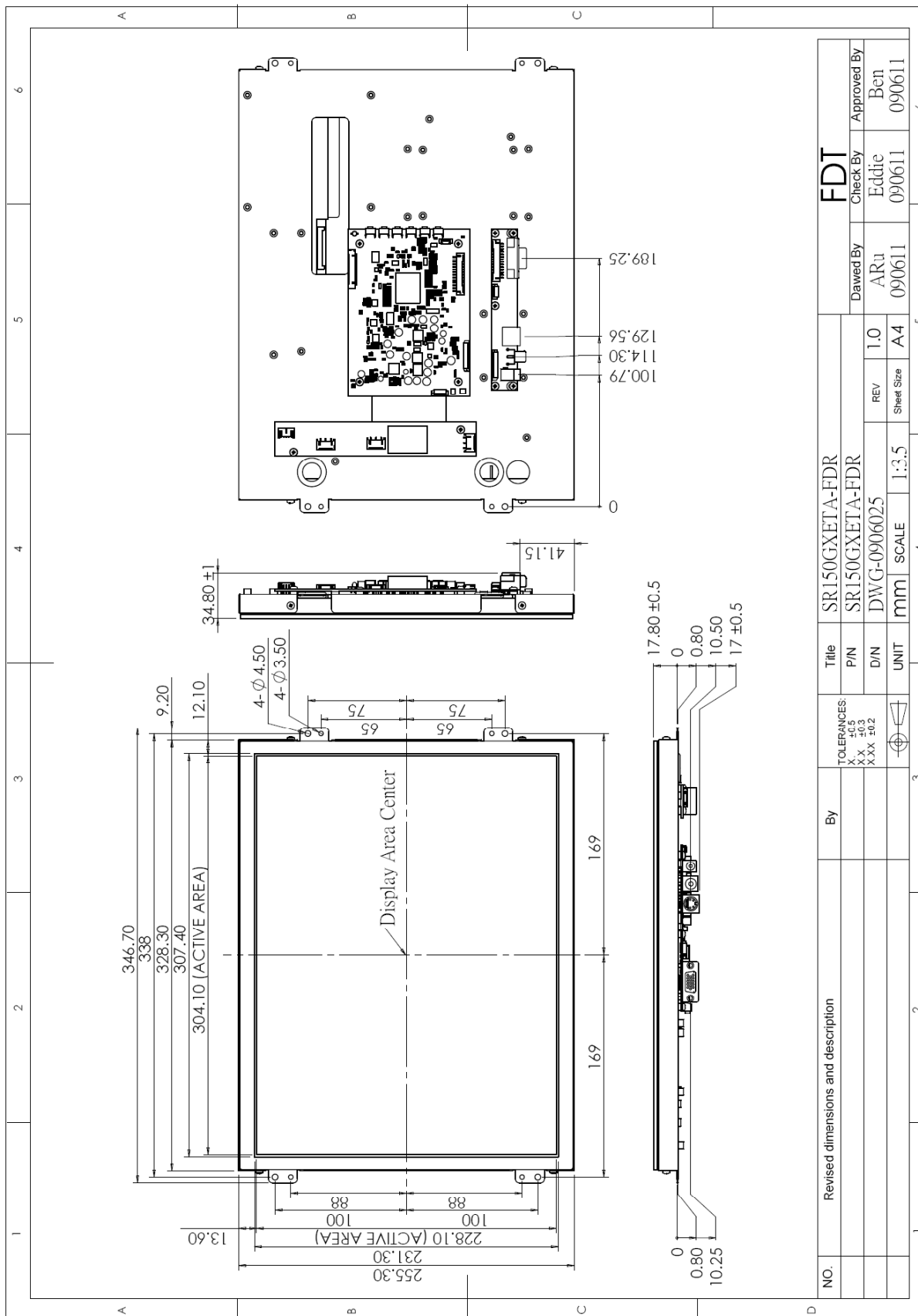

6.2 SR150GXECA-FDR

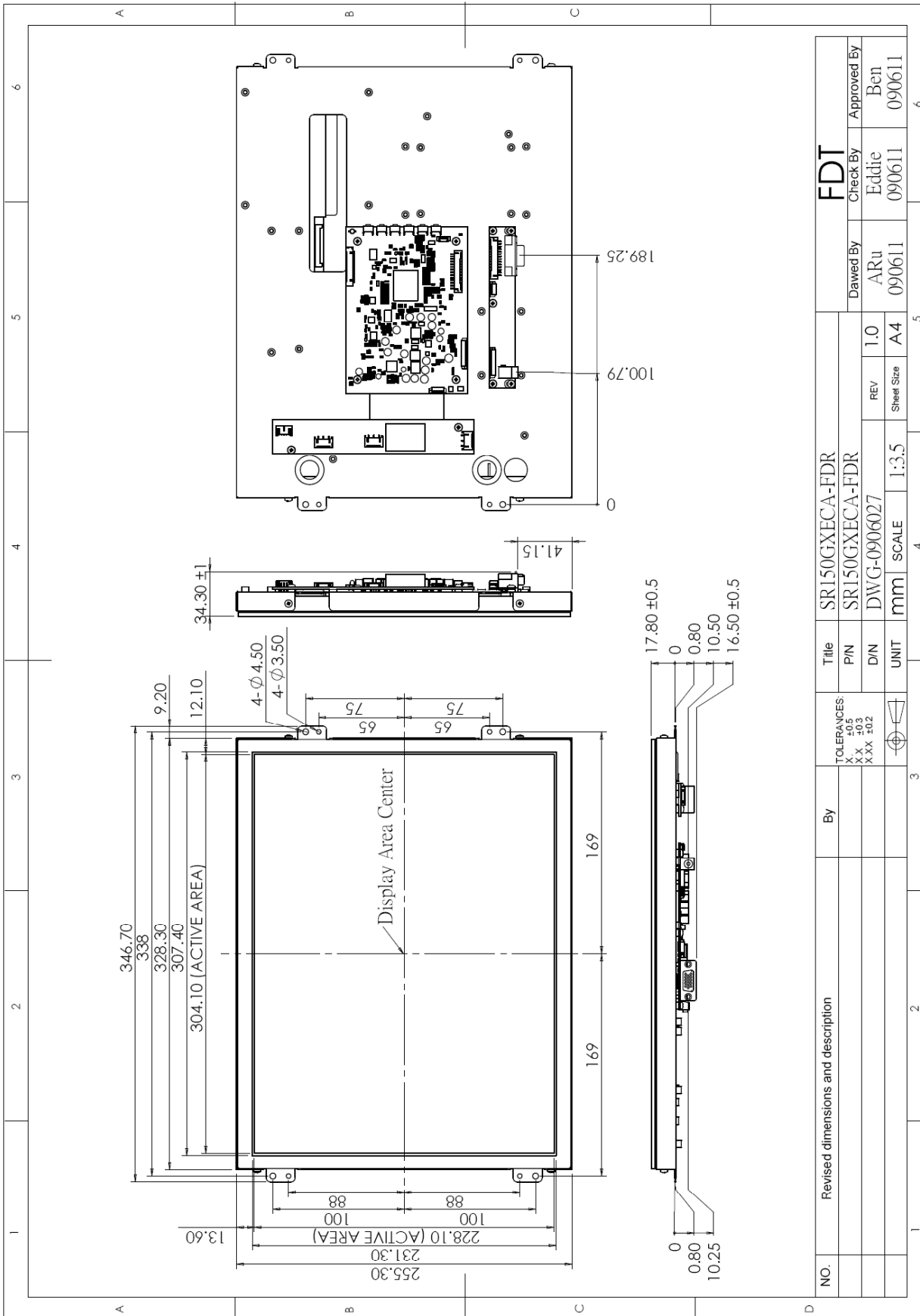

7. Packing List

Before you begin installing the TFT-LCD Module, please make sure that the following materials have been shipped:



A. LASTD12030-FDR



B. LAACD18000-FDR



C. LAVDO18000-FDR



D. LASVO18000-FDR



E. LAVGA16000-FDR

A. AC to DC Adapter (100-240V_{AC} 50-60Hz or +12V_{DC} @ 3A)

B. Power Cord

C. Video Cable

D. S-Video Cable

E. VGA Cable

If any of these items are missing or damaged, contact your distributor or sales representative immediately.

8. Installing the Monitor

8.1 Power cable connection:

Connect the power cord to the AC outlet, and connect the power to the monitor through the AC/DC adapter.

8.2 VGA signal cable connection:

Plug one end of the 15-pin signal cable to the VGA connector at the rear of the PC system and the other end to the TFT-LCD Module.

Secure the connectors with the screws on the cable connector at both ends.

8.3 Video / S-Video Cable connection:

If required, connect Video / S-Video Cable from the TFT-LCD Module to the DVD or CCD Camera.

8.4 Switch on the power:

Switch on the power switch on the rear cover of the TFT-LCD Module.

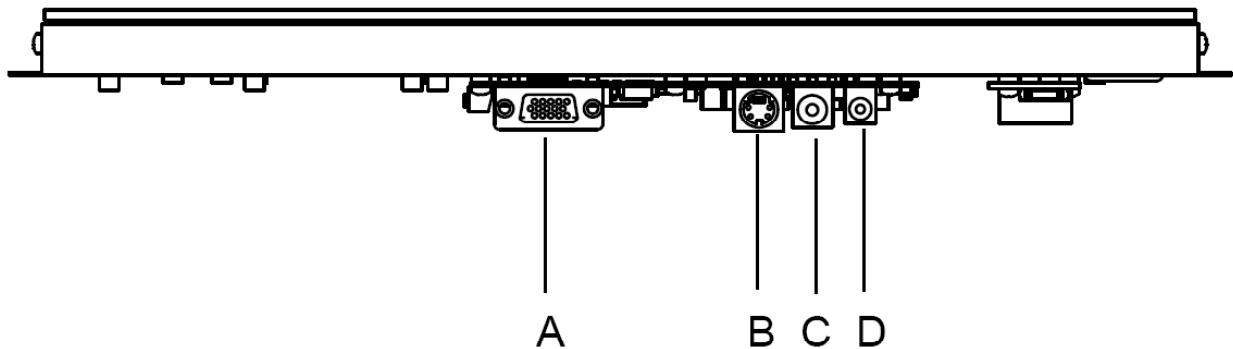

A. VGA D-sub 15 (Female)

B. S-Video (Y/C Video) In

C. Video (CVBS) In

D. DC-In (+12V_{DC} The DC jack ID: 5.5 ϕ OD: 2.1 ϕ core is positive)

FLAT DISPLAY TECHNOLOGY

■ SR150GXEA-FDR V0.0 

9. OSD Control

9.1 Menu Operation

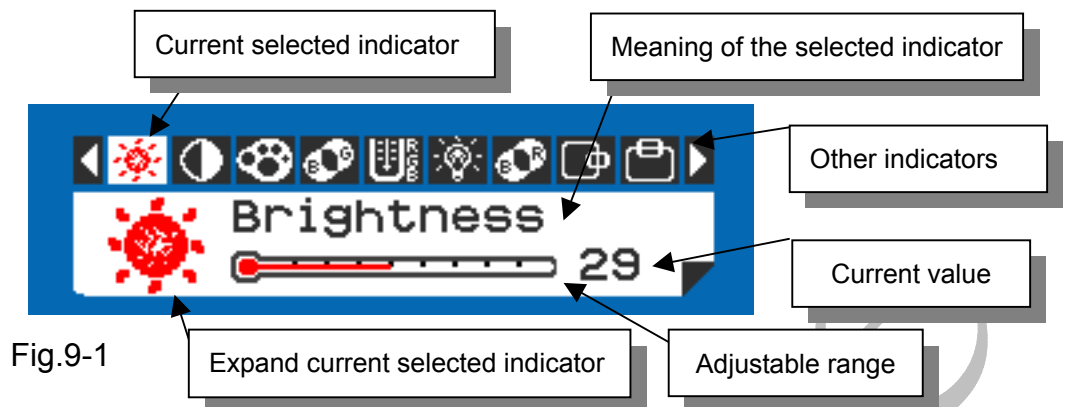
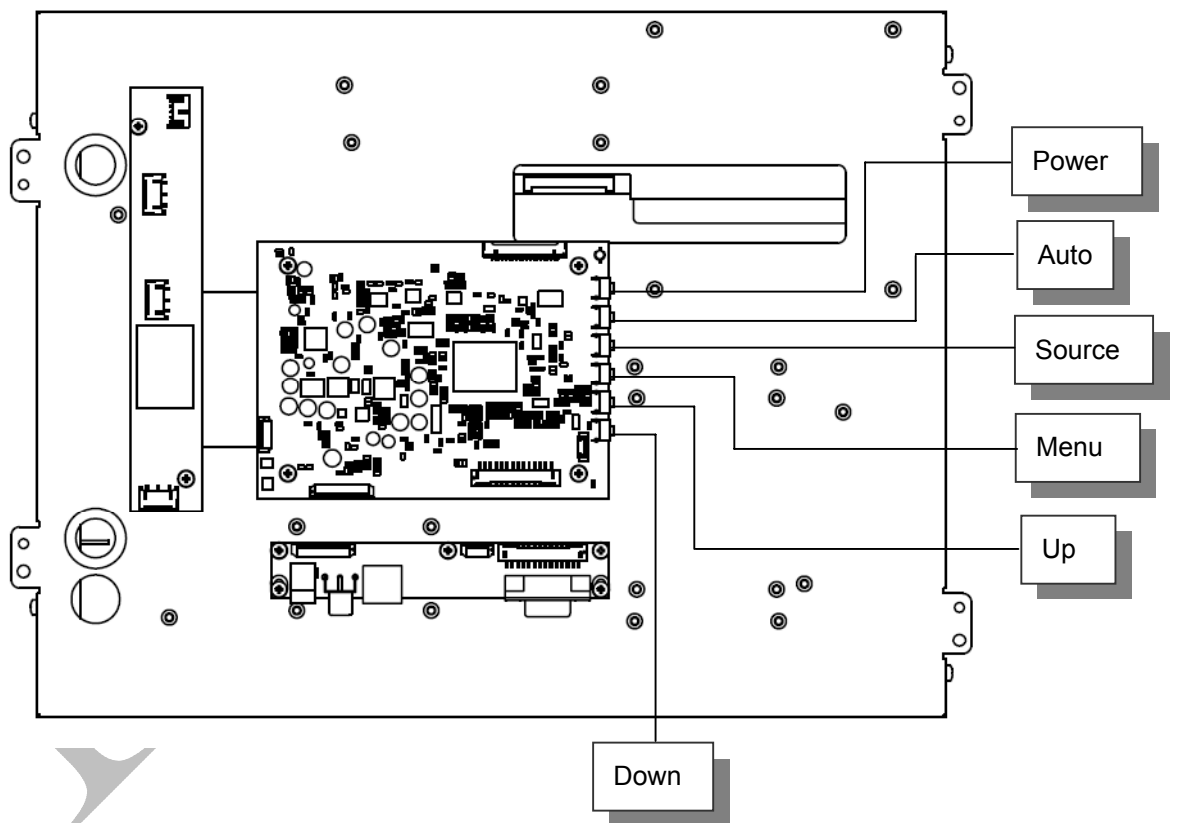

Fig.9-1



Operations of key board :

1. To navigate the menu, press [MENU]. (Fig.9-1)
2. The indicator lighting up in white color is the selected adjustment item.
3. To Next Item of the menu, press [MENU] again.
4. The operations below are only available when "Menu" is started.
5. Press [UP] / [DOWN] to adjust the value of the selected item.

Overview of the menu :

Firmware Version must be \geq VER 0.26















Indicator	Meaning	Adjustable range	For	Remark
	Brightness	0 ~ 64	AV / S-Video / VGA	Adjust-Bar
	Contrast	0 ~ 64	AV / S-Video / VGA	Adjust-Bar
	Color	0 ~ 64	AV / S-Video	Adjust-Bar
	Tint	0 ~ 32	AV / S-Video	Adjust-Bar
	Sharpness	0 ~ 16	AV / S-Video	Adjust-Bar
	Dimmer	0 ~ 9	AV / S-Video / VGA	
	Color Tone	Normal / Warm / Cool	AV / S-Video / VGA	
	H-Position	-25 ~ +25	VGA	Balance-Bar
	V-Position	-10 ~ +10	VGA	Balance-Bar
	Auto		VGA	
	Scan	Over Scan / Under Scan	AV / S-Video	
	Information		AV / S-Video / VGA	Fig.9-2
	Setup		AV / S-Video / VGA	Fig.9-3
	Factory Set		AV / S-Video / VGA	
	Exit		AV / S-Video / VGA	

Fig.9-2







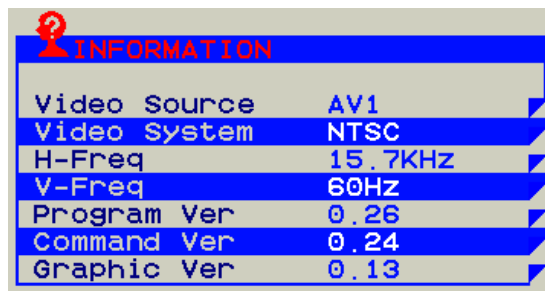

FLAT DISPLAY TECHNOLOGY

SR150GXEA-FDR V0.0 

Setup Menu :



Fig.13-3

Indicator	Meaning	Adjustable range	Function	Remark
	Show Status	ON / OFF	Show signal status.	ON: Show OFF: Hidden
	Blue Screen	ON / OFF	If loss signal will put on the blue or black screen.	ON: Blue OFF: Black
	Auto Power On	ON / OFF	Power input module will be auto turn on.	ON: Auto OFF: Manual
	Auto Saving	OFF / 3s / 5s / 15s / 30s	If signal lost over setting times will be power off.	ON: Auto OFF: Normal
	Detect Source	ON / OFF	Auto detection which source is existence and change.	ON: Auto OFF: Normal
	Return			

Note : VGA only type don't have Detect Source function.

9.2 Operations

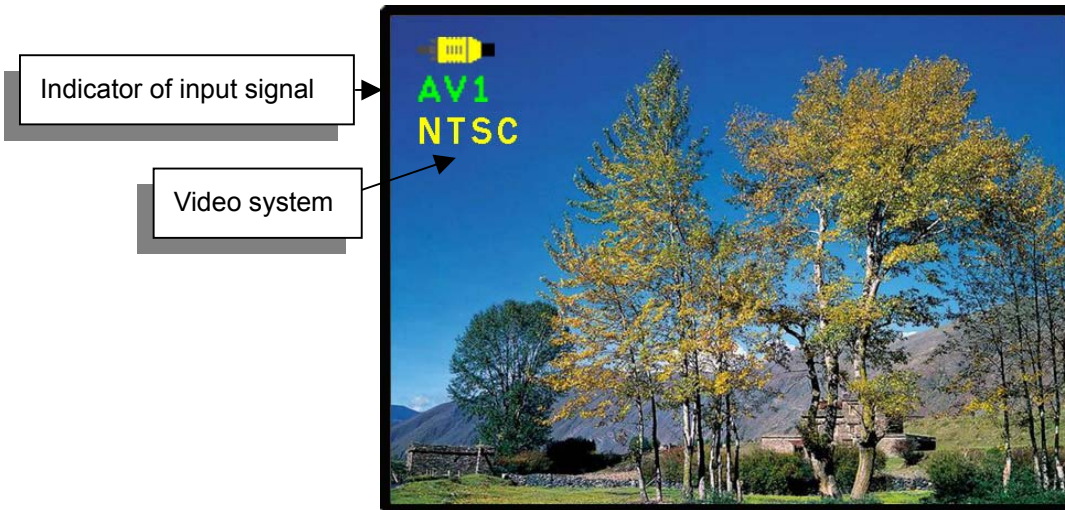





Fig.9-4

[Power] : Monitor power on / off

[Source] : Input signal switch

Overview of input signals :

Indicator	Input signal	Interface	Video system
	AV1	Composite	NTSC / PAL / SECAM
	S-Video1	Y/C	NTSC / PAL / SECAM
	VGA	Analog RGB	640x480_60 / 800x600_60 / 1024x768_60 / 1280x1024_60

10. Trouble Shooting

If experiencing trouble with the monitor, or it fails to operate correctly, please refer to the following instructions before calling for repairs.

Condition	Check Point
1. The picture does not appear	<ul style="list-style-type: none">● Check to see that all the I/O and power cables is firmly seated in the socket.● Check the Power LED is Lighting When the monitor was turned ON.● Check if the brightness control is at the appropriate position, not at the minimum.
3. The screen is not synchronized	<ul style="list-style-type: none">● Check if the I/O signal cable is firmly seated in the socket.● Check if the output level matches the input level.● Make sure the signal timings of the computer system are with in the specification of the monitor.
4. The position of the screen is not in the center	<ul style="list-style-type: none">● Adjust the H-position, and V-position, or perform the auto adjustment Or Factory Set.
5. The screen is too bright (too dark).	<ul style="list-style-type: none">● Check if the brightness or contrast control is at the appropriate position, not at the Maximum (Minimum).
6. The Screen is shaking or waving	<ul style="list-style-type: none">● Press the Auto adjustment control to adjust. Moving all objects which emit a magnetic field such as motor or transformer, away from the monitor. Check if the specific voltage is applied.● Check if the signal timing of the computer system is within the specification of monitor.

If you are unable to correct the fault by using this chart, stop using your monitor and contact us.