



§ SPECIFICATION APPROVAL SHEET §

Fdt Tech Module No: **LOF101GF7P-80R**

Description: **10.1" Digital TFT-LCD Module**

SPEC No.: **SAS-1709001**

Version: **0.1**

Issue Date: **February 9, 2018**

※ This approval sheet contains 18 pages including the cover and appendix.

Customer:	Approved By:
Date: / / 18	

Approved By: _____ Checked By: _____ Designed By: _____



1. General Description

1.1 Features

- 10.1" (1280x800) Digital TFT LCD
- Aspect Ratio: 16:10
- Input Signal VGA / HDMI 1.3a
- Maximum Support Resolution 1920x1080
- Headphone Driver, 46mW@32Ω
- Projected Capacitive Touch
- 5 Key Buttons Controls
- 9 Language OSD Menu
- LED Backlight
- Single Operation Voltage +12V

1.2 Applications

- Industrial
- Medical Environment
- Instrument Display
- Kiosk
- Security
- Signage
- Office Electronics
- Home Application
- Educate Application



2. Contents

Contents	Page
1. General Description.....	1
1.1 Features	1
1.2 Applications	1
2.Contents.....	2-3
3. Specifications.....	4
4. Block Diagram.....	4
5. Order Information.....	5
5.1 Unit	5
6. Accessories (Option).....	6
7. Pin Description.....	7-9
7.1 DC-In : Pin Assignment of Power Input (DC-Jack Inside Diameter:2.1 ϕ Outside Diameter:5.5 ϕ Side Entry Type)	7
7.2 VGA : Pin Assignment of Analog RGB Input (D-Sub 15Pin)	7
7.3 HDMI : Pin Assignment of HDMI-A Type Input (HDMI 1.3a -19Pin Female)	8
7.4 USB : Pin Assignment of Touch USB (USB A Type - Female 2.0mm, Side Entry Type)(Option)	8
7.5 Line-Out : Pin Assignment of Line-Out/Ear Phone (Option) (Outside Diameter:3.5 ϕ Side Entry Type)	8
7.6 Line-In : Pin Assignment of Line-In/Ear Phone (Option) (Outside Diameter:3.5 ϕ Side Entry Type)	9
8. Absolute Maximum Ratings.....	9
8.1 Absolute Maximum Ratings	9
9. Recommended Operating Conditions.....	9
9.1 Electrical Characteristics	9
9.2 VGA Mode Characteristics	9
10. Projected Capacitive Touch Panel Characteristics.....	10
10.1 Electrical Performance	10
10.2 Optical Performance	10
10.3 Mechanical Performance	10
10.4 Touch Panel Operation System Support	10
11. Installing the Monitor.....	11
11.1 Power cable connection	11
11.2 VGA signal cable connection	11
11.3 Switch on the power	11
12. Key Function by OSD.....	12-15
12.1 Menu Operation	12-15
13. Dimension Information.....	16
13.1 Unit (LOF101GF7P-80R)	16
14. Appendix.....	17
14.1 TFT-LCD Mechanical Specifications	17



Preliminary

3. Specifications

LCD	
Panel Size	10.1"
Resolution (Pixels)	1280x800
Luminance	255 cd/m ²
Contrast Ratio	800
View Angle	85 / 85 / 85 / 85
LED Life Time	20K (Min)
Power Requirement	
Power Input (DC Jack 2.1 ϕ)	+12 VDC
Touch Screen	
PCAP Type	USB Interface
Resistive Type Support OS	Windows / Linux / DOS / Mac / QNX
Projected Capacitive Touch Support OS	Windows / Linux

Input Signal		
VGA	D-Sub15	
HDMI	1.3a	
Audio		
Headphone Driver (Line In & out)	46mW@32 Ω Phone Jack ϕ 3.5	
Mechanical		
Construction	Aluminum Front Bezel with Completely Covered Glass and SECC steel chassis	
Mounting Type	Panel / VESA 75 x 75 Mount	
Environment		
Temperature Range	Operating	0 ~ +50 $^{\circ}$ C
	Storage	-20 ~ +60 $^{\circ}$ C
High Temperature & High Humidity (Non-condensing)	Operating	+40 $^{\circ}$ C / 90%

4. Block Diagram

LOF101GF7P-80R

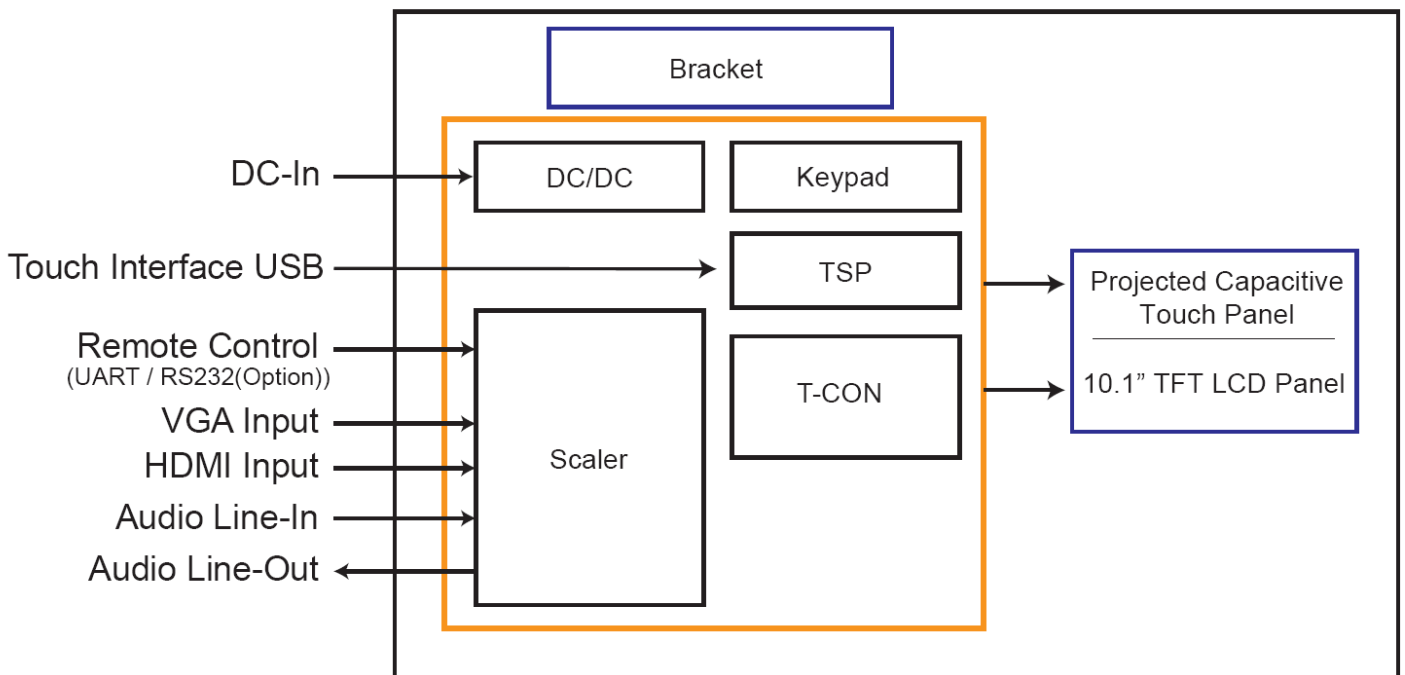



5. Order Information

5.1 Unit

Item	LOF101GF7P-80R	Unit	Remark
VGA	⊙		
HDMI	⊙		
Touch Panel Type	Projected Capacitive Touch		
Touch Screen Interface	USB		
Headphone Driver (Line In & out)	⊙		
5 Keys	⊙		
Dimensions	250.26 x 168.90 x 26.7	mm	
Weight	786	g	±10%
Condition	Standard		

Note: 1. The assembling of panel and bracket is aimed for delivery, packaging and experiment. If the demand of shockproof and long-term fix, pls. have it into consideration of mechanism design.

Item	Condition
RS232 Remote Control External Key	Customized

Note: Special order condition will apply to non-standard items and pls. contact salespersons in FDT.

6. Accessories (Option)

Before you begin installing the Open Frame, please make sure that the following materials have been shipped:



A. LASTD12033-FDR



B. LAACD18000-FDR



C. LACABLE068-FDR



D. LAVGA18000-FDR



E. LAUSB18000-FDR



F. LACABLE070-FDR



G. LAVCD00002-FDR

- A. AC to DC Adapter (L:1500mm,100-240V_{AC} 50-60Hz to +12V_{DC} @ 3.3A, ϕ 2.1)
- B. Power Cord (L:1800mm, Plug Type B for USA)
- C. HDMI Cable (L:1800mm)
- D. VGA Cable (L:1800mm)
- E. USB Cable (L:1800mm)
- F. AUDIO Cable (L:1800mm)
- G. Touch Screen Driver CD Disk / User Manual

7. Pin Description

7.1 DC-In : Pin Assignment of Power Input (DC-Jack Inside Diameter:2.1 φ Outside Diameter:5.5 φ Side Entry Type)

Pin No.	Symbol	I/O	Description	Remark
1	DC-In	I	+12Vdc Input Voltage	
2	GND	-	Power Ground	

7.2 VGA : Pin Assignment of Analog RGB Input (D-Sub 15Pin)

Pin No.	Symbol	I/O	Description	Remark
1	RI+	I	Analog Red Signal	
2	GI+	I	Analog Green Signal	
3	BI+	I	Analog Blue Signal	
4	GND	-	Ground	
5	VGA-Det	I	VGA Detect	
6	AGND	-	Analog Ground	
7	AGND	-	Analog Ground	
8	AGND	-	Analog Ground	
9	VGA5V	-	VGA +5Vdc Input	
10	GND	-	Ground	
11	GND	-	Ground	
12	VGA_SDA	-	DDC2 Data	
13	HS_IN	I	TTL Horizontal sync.	
14	VS_IN	I	TTL Vertical sync.	
15	VGA_SCL	-	DDC2 Clock	

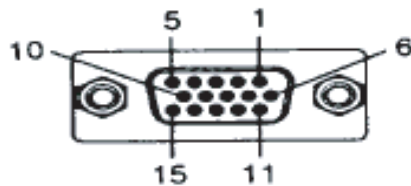

7.3 HDMI : Pin Assignment of HDMI-A Type Input (HDMI 1.3a -19Pin Female)

Pin No.	Symbol	I/O	Description	Remark
1	DATA2+	I	Positive HDMI Input for B Link Data Channel 2	
2	DET_HDMI	-	HDMI Detect	
3	DATA2-	I	Negative HDMI Input for B Link Data Channel 2	
4	DATA1+	I	Positive HDMI Input for B Link Data Channel 1	
5	GND	-	Ground	
6	DATA1-	I	Negative HDMI Input for B Link Data Channel 1	
7	DATA0+	I	Positive HDMI Input for B Link Data Channel 0	
8	GND	-	Ground	
9	DATA0-	I	Negative HDMI Input for B Link Data Channel 0	
10	DCLK+	I	Positive HDMI Input for B Link Clock Channel	
11	GND	-	Ground	
12	DCLK-	I	Negative HDMI Input for B Link Clock Channel	
13	NC	-	No Connection	
14	NC	-	No Connection	
15	HDMI_SCL	I	DDC2 Clock	
16	HDMI_SDA	I	DDC2 Data	
17	GND	I	DDC/CEC Ground	
18	HDMI5V	I	HDMI +5Vdc Input	
19	HDMI_HPD	I	Hot Plug Detect	

8.4 USB : Pin Assignment of Touch USB (USB A Type - Female 2.0mm, Side Entry Type)(Option)

Pin No.	Symbol	I/O	Description	Remark
1	VBUS	-	USB VCC	
2	D-	-	DATA (-)	
3	D+	-	DATA (+)	
4	DGND	-	Digital Ground	

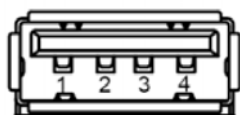

7.5 Line-Out : Pin Assignment of Headphone Line-Out (Outside Diameter:3.5 φ Side Entry Type)

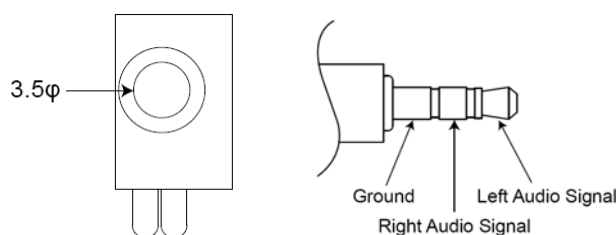

7.6 Line-In : Pin Assignment of Headphone Line-In (Outside Diameter:3.5 φ Side Entry Type)

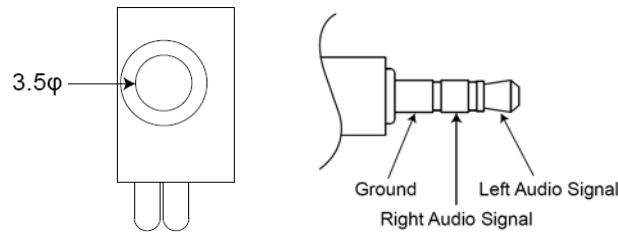

8. Absolute Maximum Ratings

8.1 Absolute Maximum Ratings

Parameter	Symbol	Min	Max	Unit	Remark
Input Voltage	Vin	+11	+13.5	V	
Analog RGB Input Signal	Analog RGB in	0.5	2.0	Vp-p	
Digital Input Signal	TTL	0.3	3.6	V	
HDMI Input Signal		-	165	MHz	
Operating Temp.		0	+50	°C	
Storage Temp.		-20	+60	°C	
High Temperature & High Humidity (Non-condensing)		-	+40 / 90	°C / %	

9. Recommended Operating Conditions

9.1 Electrical Characteristics

Parameter	Symbol	I/O	Min	Typ	Max	Unit	Note
Input Voltage	DC-in	I	+11.5	+12	+13	V	
Total Current	I-in	I	-	580	-	mA	+12V
Power Consumption		I	-	6.96	-	W	±15% @Without Headphone
Output Voltage	VDD	O	3.2	3.3	3.4	V	
Analog RGB Input Signal	Analog RGB in	RGB	I	0.7	-	Vp-p	@75Ω
HDMI Input Signal			-	-	165	MHz	

9.2 VGA Mode Characteristics

Dots per inch	H	Unit	Polarity	V	Unit	Polarity	Note
640 × 480	31.47	KHz	Positive	59.9	Hz	Positive	
800 × 600	37.88	KHz	Positive	60.3	Hz	Positive	
1024 × 768	48.36	KHz	Positive	60	Hz	Positive	
1280 × 800	49.2	KHz	Positive	59.7	Hz	Positive	
1280 × 1024	63.98	KHz	Positive	60	Hz	Positive	
1600 × 1200	75	KHz	Positive	60	Hz	Positive	
1920 × 1080	67.5	KHz	Positive	60	Hz	Positive	



10. Projected Capacitive Touch Panel Characteristics

10.1 Electrical Performance

Parameter	Symbol	Min	Typ	Max	Unit	Note
Operating Voltage		-	-	5V		

10.2 Optical Performance

Parameter	Specifications
Light Transmittance	Min 85%

10.3 Mechanical Performance

Parameter	Specifications
Input Method	Finger
Interface	USB
Surface Hardness	7H
Cover Spec.	T=1.2mm Black Printing
Knock Test	≥ 10 Million times

10.3 Touch Panel Operation System Support

Driver Vender : ITE (ITE Tech. Inc.)

OS	Version	Interface
Windows	Windows 7	USB
	Windows 8 / 8.1	
	Windows 10	
Linux	Kernel 3.0.8 and above	USB

Note: 1. How to use Touch Driver, please refer to Readme of Touch Screen Driver CD Disk (LAVCD00002-FDR).

2. Please refer to the FDT website for the latest driver version and support operating system.

FDT website: <http://www.fdt.com.tw>

11. Installing the Monitor

11.1 Power cable connection:

Connect the power cord to the AC outlet, and connect the power to the monitor through the AC/DC adapter.

11.2 VGA signal cable connection:

Plug one end of the 15-pin signal cable to the VGA connector at the rear of the PC system and the other end to the Open Frame monitor.

Secure the connectors with the screws on the cable connector at both ends.

11.3 Switch on the power:

Switch on the power switch on the rear cover of the Open Frame Monitor.

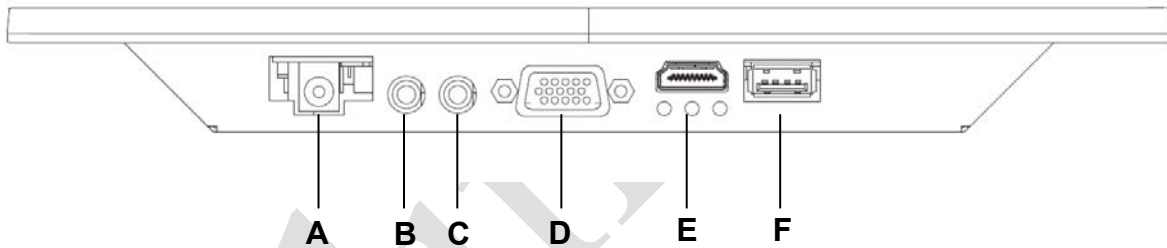

- A. DC-In (+12V_{DC} The DC jack core is positive)
- B. Line-Out : Phone Jack ϕ 3.5
- C. Line-In : Phone Jack ϕ 3.5
- D. VGA D-sub 15 (Female)
- E. HDMI
- F. USB (For Touch Controller)

12. Key Function by OSD

12.1 Menu Operation

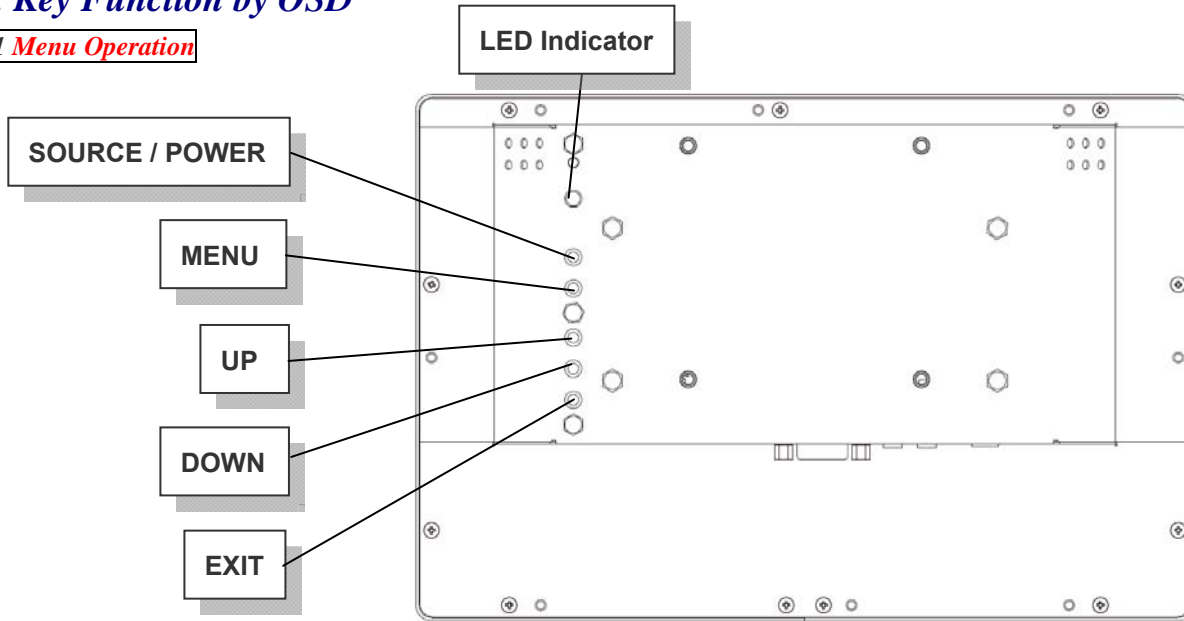

OSD ICON Instructions :

1. POWER : Power On/Off (※Press for 3 secs to turn off)
2. MENU / ENTER : (After turning on MENU, only ENTER is available)
3. UP : Move Upward / Increase Value / Option Switch
4. DOWN : Move Downward / Decrease Value / Option Switch
5. EXIT : Return to Previous Page
6. LED Indicator
 - Waiting : Flickering Green
 - Power ON : Green
 - Power OFF : Red

Save OSD Setting:

1. EXIT MENU and settings will be saved automatically
2. Settings will be saved as well when MENU shuts down automatically

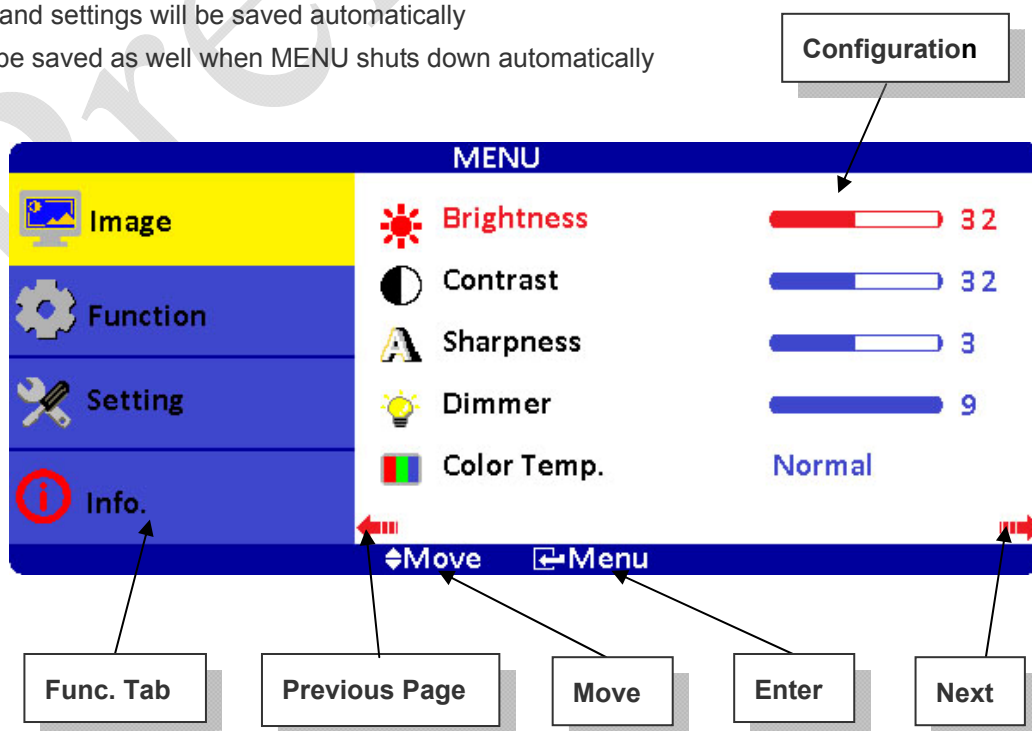

Overview of the Menu :



Image

Indicator	Meaning	Default	Adjustable range	Remark
	Brightness	32	0~63	Adjust-Bar
	Contrast	32	0~63	Adjust-Bar
	Sharpness	3	1~5	Adjust-Bar
	Dimmer	15	0~15	Adjust-Bar
	Color Temp.	Normal	Normal / Warm / Cool	
	H-Position	0	-25~+25	VGA only
	V-Position	0	-25~+25	VGA only
	Clock	0	-25~+25	VGA only
	Phase	32	0~63	VGA only
	Auto	By different resolution		VGA only
	Exit			



Function

ICON	Meaning	Default	Adjustable range	Function	Remark
	Show Status	On	On / Off	Information of input source	ON: Show ; OFF: Hidden
	Blue Screen	On	On / Off	No signal input shows blue or black screen.	ON: Blue ; OFF: Black
	Auto Power On	On	On / Off	Modules turns on automatically without power key input.	ON: Auto ; OFF: Manual
	Detect Source	On	On / Off	Auto detect input source.	ON: Auto ; OFF: Normal
	Auto Power Saving	Off	6s / 15s / 30s / Off	Modules go ready when no input source is detected.	ON: Auto ; OFF: Normal
	Auto Sleep	Off	15M / 30M / 60M / Off	Modules go sleep when set timing is out.	ON: Auto ; OFF: Normal
	Exit				

Note : After configuration is set, RESET won't restore to default setting.



Setting

Indicator	Meaning	Default	Adjustable range	Remark
	Source	VGA	VGA / HDMI	
	Volume	32	0~63	
	Mute	Off	On / Off	On : Mute · Off : Sound
	Mirror	Off	On / Off	Left-Right Reversal
	Flip	Off	On / Off	Upside Down
	Language	English	English / 中文 / 日本語 / 한국의 / Française / Deutsch / Italiano / Española / Português	
	Reset			Restore to default
	Exit			



Info.

MENU

Image	Source : VGA
Function	Resolution : 1280x800
Setting	H-Position : 49.2KHz V-Position : 59.7Hz
Information	Program Ver : 1.00 Command Ver : 1.00

↕Move ↩Exit / Menu ▶▶▶▶

Hot Key When OSD Menu is Off :

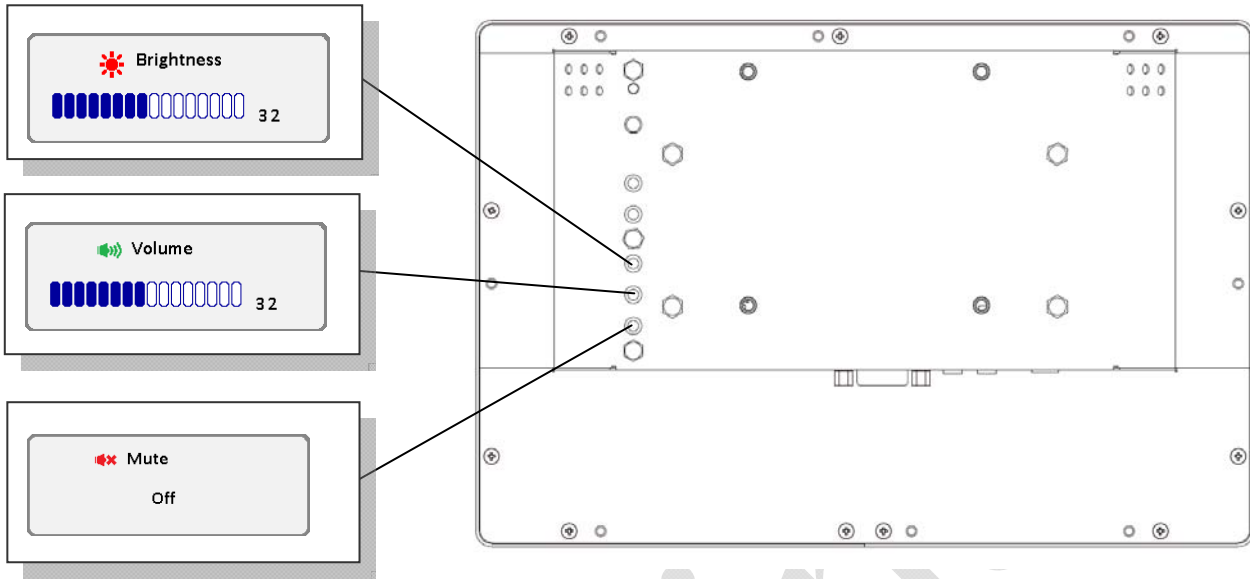

Information of Input Source and Functionality :

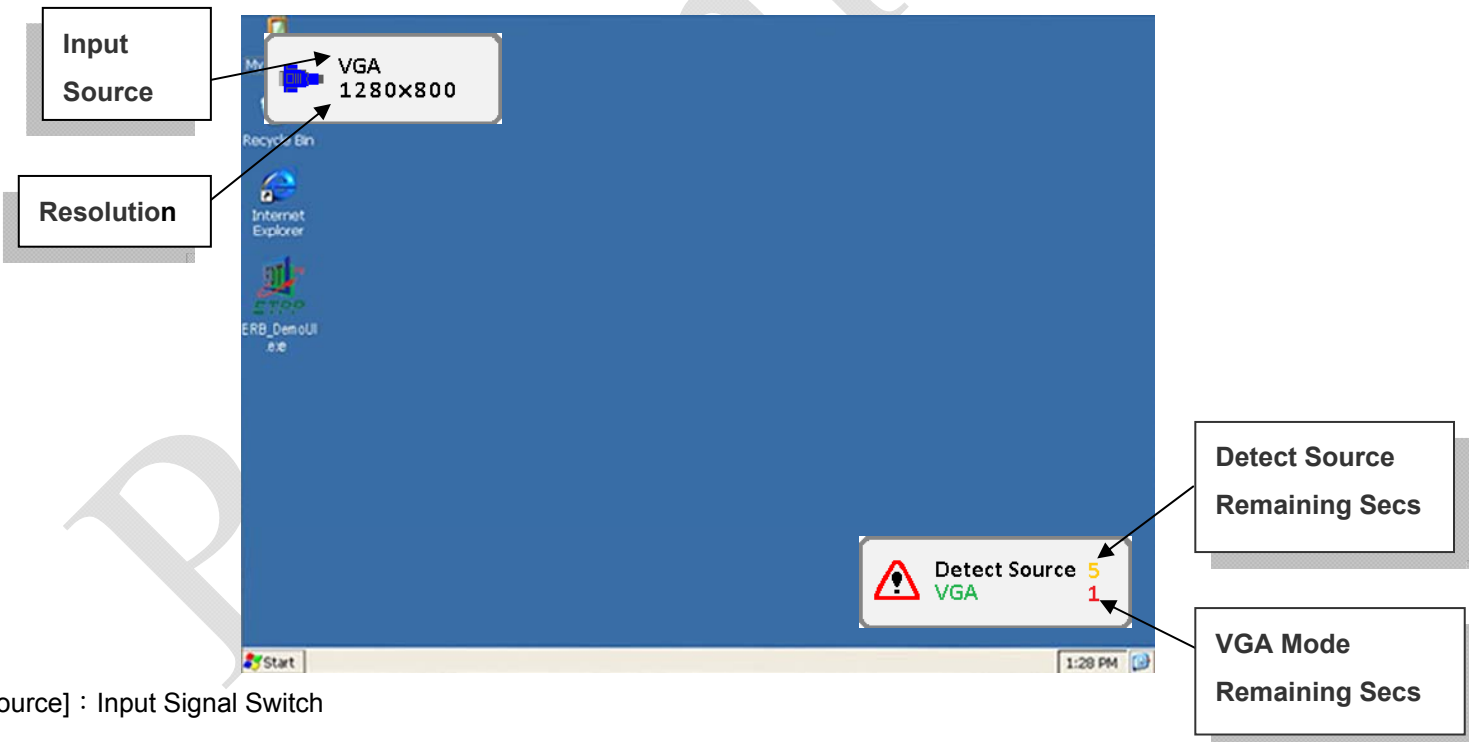

[Source] : Input Signal Switch

Overview of Input Signals :

Indicator	Interface
	VGA
	HDMI

13. Dimension Information

13.1 Unit (LOF101GF7P-80R)

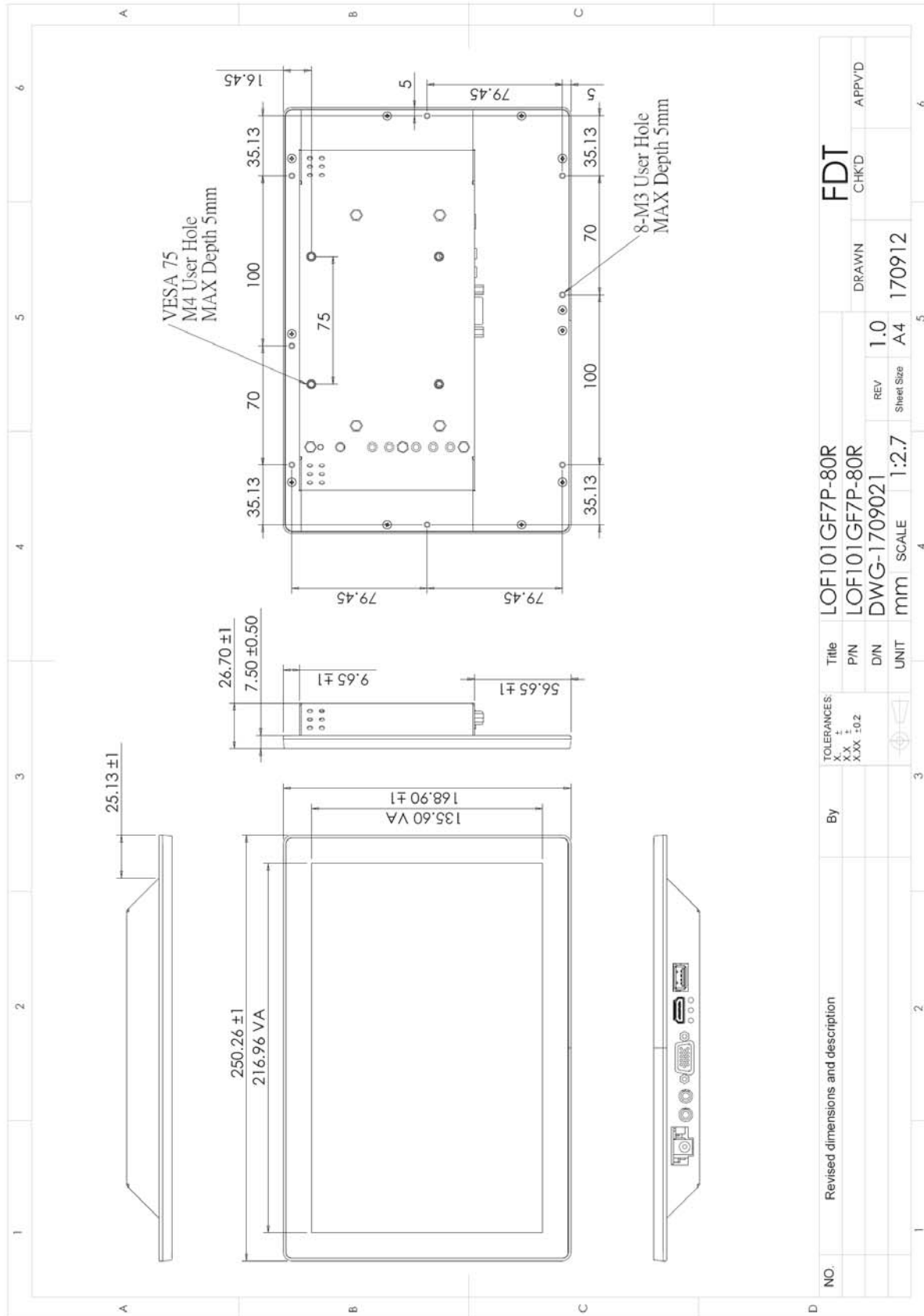



14. Appendix

14.1 TFT-LCD Mechanical Specifications

Parameter	Specifications	Unit
Screen Size	10.1 (diagonal)	Inch
Display Format	1280 x (R.G.B) x 800	Dot
Active Area	216.96 (H)× 135.6(V)	mm
Pixel Pitch	0.1695(H) x 0.1695(V)	mm
Pixel Arrangement	RGB stripe	

14.2 TFT-LCD Optical Characteristics

Parameter	Symbol	Condition	Min	Typ	Max	Unit	Remark
Viewing Angle	Horizontal	Left	75	85	---	deg	
		Right	75	85	---	deg	
	Vertical	Top	75	85	---	deg	
		Bottom	75	85	---	deg	
Contrast Ratio	CR	At optimized Viewing angle	600	800	---	---	
Luminance without PCAP	L		250	300	---	cd/m ²	
LED Life Time		25°C	20000	---	---	Hrs	Note

Note: The "LED Life Time" is defined as the module brightness decrease to 50% original.