



## § SPECIFICATION APPROVAL SHEET §

Fdt Tech Module No: **LP070A065P-FNR**

---

Description: **7" Digital TFT-LCD Module**

---

SPEC No.: **SAS-1603004**

---

Version: **0.0**

---

Issue Date: **March 28, 2016**

---

※ This approval sheet contains 17 pages including the cover and appendix.

<p>Customer: _____</p> <p>Date:     /     / 16</p>	<p>Approved By: _____</p>
---	---------------------------

Approved By: \_\_\_\_\_      Checked By: \_\_\_\_\_      Designed By: \_\_\_\_\_

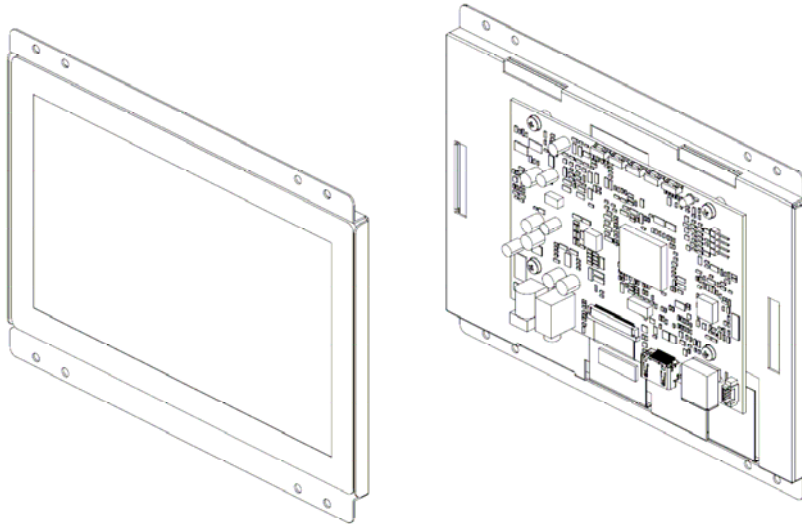

## 1. General Description

### 1.1 Features

- 7" (1024x600) Digital TFT LCD
- Aspect Ratio: 16:9
- Input Signal HDMI 1.3a
- Maximum Support Resolution 1920x1080
- Headphone Driver, 46mW@32Ω
- Projected Capacitive Touch
- 5 Key Buttons Control
- UART / RS232 Serial Remote Control (Optional)
- 8 Language OSD Menu
- LED Backlight
- Single Operation Voltage +5V

### 1.2 Applications

- Industrial
- Medical Environment
- Instrument Display
- Kiosk
- Security
- Signage
- Office Electronics
- Home Application
- Educate Application



## 2. Contents

Contents	Page
<b>1. General Description</b> .....	1
1.1 Features	1
1.2 Applications	1
<b>2. Contents</b> .....	2
<b>3. Specifications</b> .....	3
<b>4. Block Diagram</b> .....	3
<b>5. Order Information</b> .....	4
6.1 Unit	4
<b>6. Accessories (Option)</b> .....	5
<b>7. Operation manual / Connection</b> .....	6
12.1 Driver Board Manual	6
<b>8. Pin Description</b> .....	7-8
8.1 J101 : Pin Assignment of Power Input (DC-Jack Inside Diameter:2.5 $\phi$ Outside Diameter:5.5 $\phi$ Side Entry Type)	7
8.2 J702: Pin Assignment of UART (Pitch 1.25mm 4Pin, Top Entry Type)	7
8.3 J401 : Pin Assignment of HDMI-A Type Input (HDMI 1.3a -19Pin Female)	7
8.4 J601D : Pin Assignment of Key Board (Pitch 1.25mm 12Pin , Side Entry Type) (Option)	8
8.5 J701 : Pin Assignment of Touch USB (USB A Type - Female 2.0mm, Side Entry Type )	8
8.6 J301 : Pin Assignment of Phone Jack (Outside Diameter:3.5 $\phi$ Side Entry Type)	8
<b>9. Absolute Maximum Ratings</b> .....	9
9.1 Absolute Maximum Ratings	9
<b>10. Recommended Operating Conditions</b> .....	9
10.1 Electrical Characteristics	9
10.2 Support Display Mode Characteristics	9
<b>11. Projected Capacitive Touch Panel Characteristics</b> .....	10
11.1 Electrical Performance	10
11.2 Optical Performance	10
11.3 Mechanical Performance	10
11.4 Touch Panel Operation System Support	10
<b>12. Key Function by OSD</b> .....	11-14
14.1 Menu Operation	11-14
<b>13. Dimension Information</b> .....	15
7.1 Unit (LP070A065P-FNR)	15
<b>14. Appendix</b> .....	16
14.1 TFT-LCD Mechanical Specifications	16
14.2 TFT-LCD Optical Characteristics	16

### 3. Specifications

LCD	
Panel Size	7"
Resolution (Pixels)	1024x600
Color	262K
Luminance	213 cd/m <sup>2</sup>
Contrast Ratio	700
Viewing Angle	75 / 75 / 70 / 75
LED Life Time	15K (Min)
Power Requirement	
Power Input (DC Jack 2.5 φ)	+5V <sub>DC</sub>
Power Consumption	3.6 Watts
Touch Screen	
Resistive Type	USB Interface
Projected Capacitive Touch Support OS	Windows / Linux

Input Signal	
HDMI	1.3a
Audio	
Headphone Driver	46mW@32Ω Phone Jack φ 3.5
Controls	
Key	5 Buttons
Serial Remote Control	UART / RS232 (Option)
Environment	
Operating Temp.	-10~+40°C
Storage Temp.	-20~+60°C
High Temperature & High Humidity (Non-condensing)	+40°C / 90%

### 4. Block Diagram

LP070A065P-FNR

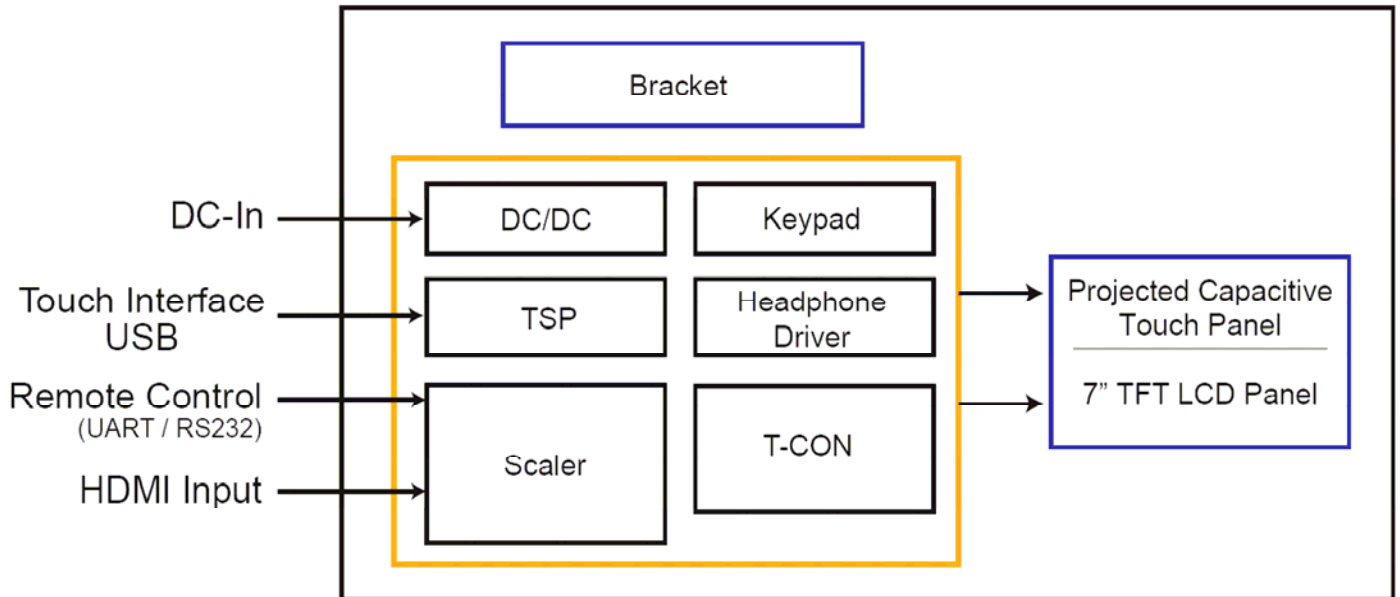



## 5. Order Information

### 5.1 Uni

Parameter	LP070A065P-FNR	Unit	Remark
HDMI	◎		
Touch Panel Type	Projected Capacitive Touch		
Touch Screen Interface	USB		
Headphone Driver	◎		
5 Keys	◎		
UART Remote Control	◎		
Dimension	179.8x137.8x25.1	mm	
Weight	TBD	g	±10%
Condition	Standard		

**Note: 1.** The assembling of panel and bracket is aimed for delivery, packaging and experiment. If the demand of shockproof and long-term fix, pls have it into consideration of mechanism design.

Optional Functions	
Parameter	<ul style="list-style-type: none"> <li>- RS232 Remote Control</li> <li>- External Key</li> <li>- Accessories (Refer to Page 5)</li> </ul>

## 6. Accessories (Option)

Before you begin installing the KIT, please make sure that the following materials have been shipped:



A. LASTD05030-FDR



B. LAAC818000-FDR



C. LACABLE068-FDR



D. LAUSB18000-FDR



E. LACABLE070-FDR



F. LAVCD00003-FDR

- A. AC to DC Adapter (L:1500mm,100-240V<sub>AC</sub> 50-60Hz to +5V<sub>DC</sub> @ 3A,  $\phi$  2.5)
- B. Power Cord (L:1800mm, Plug Type B for USA)
- C. HDMI Cable (L:2000mm)
- D. USB Cable (L:1800mm)
- E. AUDIO Cable (L:1800mm)
- F. Touch Screen Driver CD Disk / User Manual

7 Operation manual / Connection

7.1 Driver Board Manual

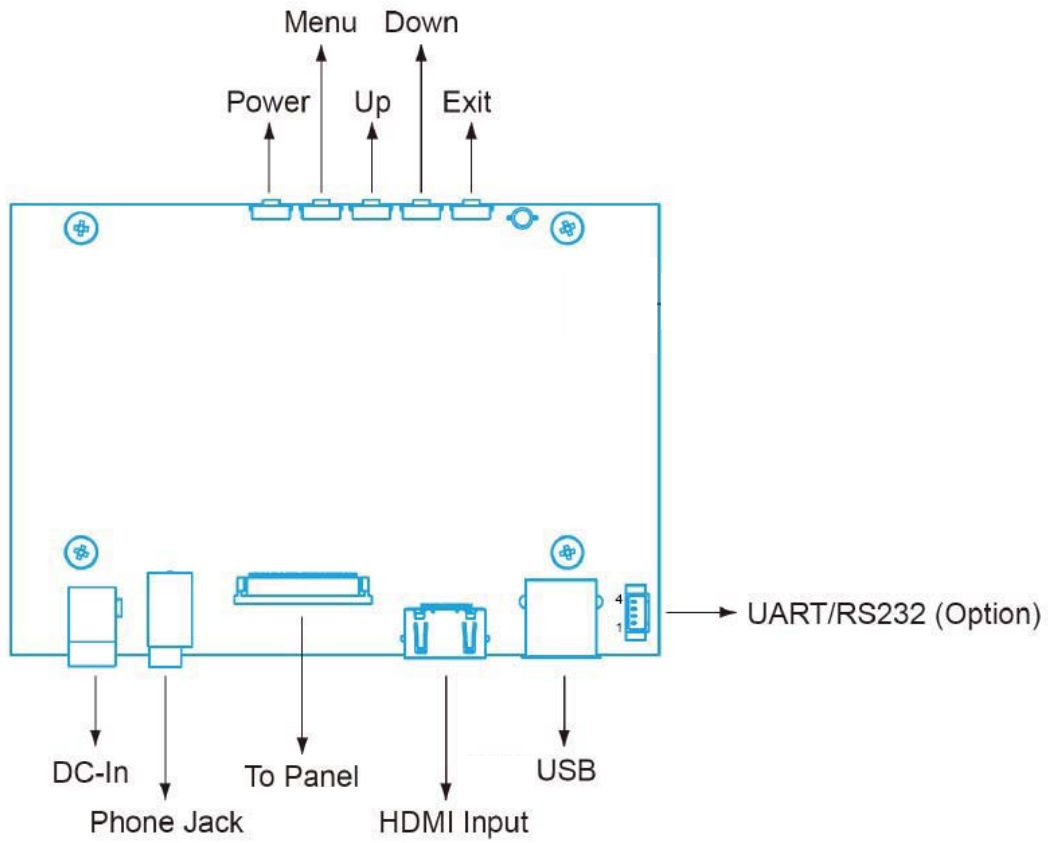

TECH

## 8. Pin Description

### 8.1 J101 : Pin Assignment of Power Input (DC Jack Inside Diameter:2.5 φ Outside Diameter:5.5 φ Side Entry Type)

Pin No.	Symbol	I/O	Description	Remark
1	DC-In	I	+5 Vdc Input Voltage	
2	GND	-	Power Ground	

### 8.2 J702 : Pin Assignment of UART (Pitch 1.25mm 4Pin, Top Entry Type)

※ FDT Connector Part No.: MS24014 (STM) [Same as 53398-0471 (MOLEX)] ;

※ FDT Matching Connector Part No.: P24014 (STM) [Same as 51021-0400 (MOLEX)].

Pin No.	Symbol	I/O	Description	Remark
1	TX / RS232 TX (Option)	O	UART / RS232 (Option) Transmission Data	
2	RX / RS232 RX (Option)	I	UART / RS232 (Option) Receive Data	
3	GND	-	Ground	
4	+3.3Vdc	O	+3.3Vdc Output Voltage	

**Note: All Functions can be controlled by UART , About UART command list please contact FDT sales.**

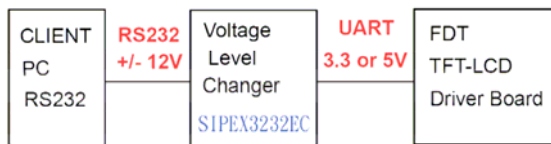

### 8.3 J401 : Pin Assignment of HDMI-A Type Input (HDMI 1.3a -19Pin Female)

Pin No.	Symbol	I/O	Description	Remark
1	DATA2+	I	Positive HDMI Input for B Link Data Channel 2	
2	DET_HDMI	-	HDMI Detect	
3	DATA2-	I	Negative HDMI Input for B Link Data Channel 2	
4	DATA1+	I	Positive HDMI Input for B Link Data Channel 1	
5	GND	-	Ground	
6	DATA1-	I	Negative HDMI Input for B Link Data Channel 1	
7	DATA0+	I	Positive HDMI Input for B Link Data Channel 0	
8	GND	-	Ground	
9	DATA0-	I	Negative HDMI Input for B Link Data Channel 0	
10	DCLK+	I	Positive HDMI Input for B Link Clock Channel	
11	GND	-	Ground	
12	DCLK-	I	Negative HDMI Input for B Link Clock Channel	
13	NC	-	No Connection	
14	NC	-	No Connection	
15	HDMI_SCL	I	DDC2 Clock	
16	HDMI_SDA	I	DDC2 Data	
17	GND	I	DDC/CEC Ground	
18	HDMI5V	I	HDMI +5Vdc Input	
19	HDMI_HPD	I	Hot Plug Detect	

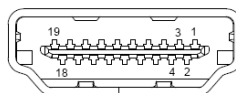



**8.4 J601D : Pin Assignment of Key Board (Pitch 1.25mm 12Pin , Side Entry Type)(Option)**

※ FDT Connector Part No.: MS240112R (STM) [Same as 53261-1219 (MOLEX)] ;

※ FDT Matching Connector Part No.: P240112 (STM) [Same as 51021-1200 (MOLEX)].

Pin No.	Symbol	I/O	Description	Remark
1	-	-	Don't Connect	
2	SW5	I	EXIT	
3	SW4	I	DOWN	
4	SW3	I	UP	
5	SW2	I	MENU / S	
6	SW1	I	POWER / SOURCE	
7	GND	-	Ground	
8	VDDP	-	VDDP +3.3Vdc Output Voltage	
9	-	-	Don't Connect	
10	RED	O	Indicator red LED for power off control	
11	GREEN	O	Indicator green LED for power on control	
12	GND	-	Ground	

**8.5 J701 : Pin Assignment of Touch USB (USB A Type - Female 2.0mm, Side Entry Type)**

Pin No.	Symbol	I/O	Description	Remark
1	VBUS	-	USB VCC	
2	D-	-	DATA (-)	
3	D+	-	DATA (+)	
4	DGND	-	Digital Ground	

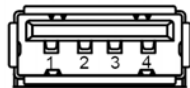

**8.6 J301 : Pin Assignment of Phone Jack (Outside Diameter:3.5 φ Side Entry Type)**

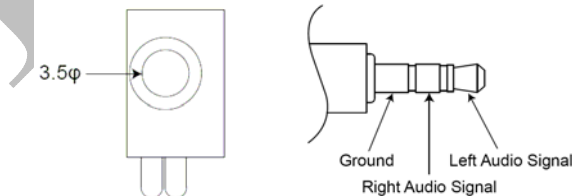



## 9. Absolute Maximum Ratings

### 9.1 Absolute Maximum Ratings

Parameter	Symbol	Min	Max	Unit	Remark
Input Voltage	V <sub>in</sub>	+4.5	+6	V	
Digital Input Signal	TTL	0.3	3.6	V	
HDMI Input Signal		-	165	MHz	
Operating Temp.		-10	+40	°C	
Storage Temp.		-20	+60	°C	
High Temperature & High Humidity (Non-condensing)		-	+40 / 90	°C / %	

## 10. Recommended Operating Conditions

### 10.1 Electrical Characteristics

Parameter	Symbol	I/O	Min	Typ	Max	Unit	Note
Input Voltage	DC-in	I	+4.8	+5	+5.8	V	
Total Current	I-in	I		720		mA	+5V
Power Consumption		I		3.6		W	±15%
Output Voltage	VDD	O	3.2	3.3	3.4	V	
HDMI Input Signal					165	MHz	

### 10.2 Support Display Mode Characteristics

Dots per inch	H	Unit	Polarity	V	Unit	Polarity	Note
800*600	37.88	KHz	Positive	60.3	Hz	Positive	
1024*600	37.54	KHz	Positive	60	Hz	Positive	
1024*768	48.36	KHz	Positive	60	Hz	Positive	
1280 × 1024	63.98	KHz	Positive	60	Hz	Positive	
1600 × 1200	75	KHz	Positive	60	Hz	Positive	
1920 × 1080	67.5	KHz	Positive	60	Hz	Positive	



## 11. Projected Capacitive Touch Panel Characteristics

### 11.1 Electrical Performance

Parameter	Symbol	Remark
Operating Voltage	DC 5.0 V	
Operating Current	30 mA	
Circuit Resistance	X-axis	< 100 K Connector
	Y-axis	< 100 K Connector
Insulation Resistance	$\geq 100 \text{ M}\Omega$	DC15V
Chatting	$\geq 50 \text{ ms}$	DC3.3V
Interface	USB	
Report Rate	> 100 Frames/sec	

### 11.2 Optical Performance

Parameter	Specifications
Transmittance	Min 85%

### 11.3 Mechanical Performance

Parameter	Specifications	Remark
Finger knocking durability	$\geq 1 \text{ Million times}$	End shape: R = 8mm, Hardness 50~60 degree Load force: 250 gf Frequency: 5 Hz
Input method	Finger	
Surface hardness	7H	750 gw

### 11.4 Touch Panel Operation System Support

OS	Version	Interface
Windows	Windows 7	USB
	Windows 8 / 8.1	
Linux	Kernel 3.0.8 and above	USB

## 12. Key Function by OSD

### 12.1 Menu Operation

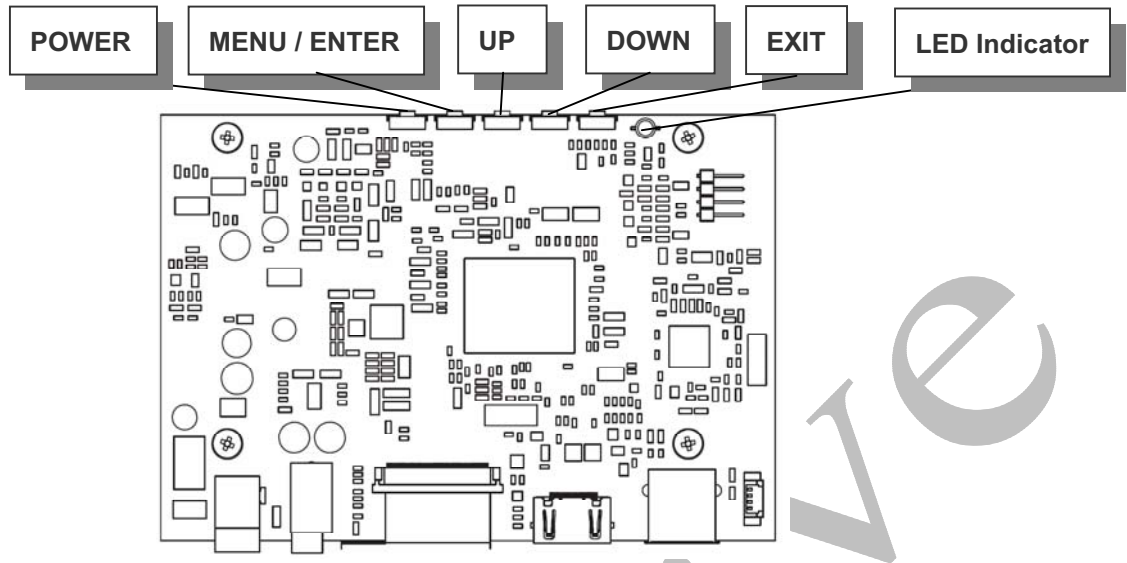

#### OSD ICON Instructions :

1. POWER : Power On/Off (※Press for 3 secs to turn off)
2. MENU / ENTER : (After turning on MENU, only ENTER is available)
3. UP : Move Upward / Increase Value / Option Switch
4. DOWN : Move Downward / Decrease Value / Option Switch
5. EXIT : Return to Previous Page
6. LED Indicator
  - Waiting : Flickering Green
  - Power ON : Green
  - Power OFF : Red

#### Save OSD Setting:

1. EXIT MENU and settings will be saved automatically
2. Settings will be saved as well when MENU shuts down automatically

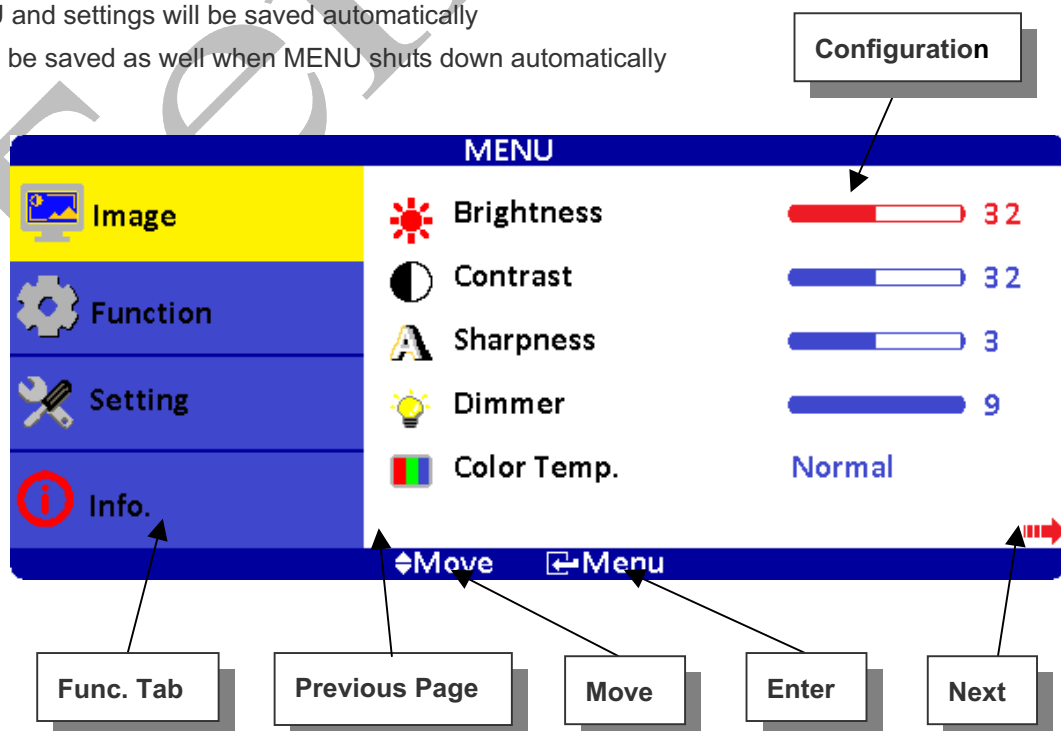

## Overview of the Menu :



### Image

Indicator	Meaning	Default	Adjustable range	Remark
	Brightness	32	0~63	Adjust-Bar
	Contrast	32	0~63	Adjust-Bar
	Sharpness	3	1~5	Adjust-Bar
	Dimmer	15	0~15	Adjust-Bar
	Color Temp.	Normal	Normal / Warm / Cool	
	Exit			



### Function

ICON	Meaning	Default	Adjustable range	Function	Remark
	Show Status	On	On / Off	Information of input source	ON: Show ; OFF: Hidden
	Blue Screen	On	On / Off	No signal input shows blue or black screen.	ON: Blue ; OFF: Black
	Auto Power On	On	On / Off	Modules turns on automatically Without power key input.	ON: Auto ; OFF: Manual
	Auto Power Saving	Off	6s / 15s / 30s / Off	Modules go ready when no input source is detected.	ON: Auto ; OFF: Normal
	Auto Sleep	Off	15M / 30M / 60M / Off	Modules go sleep when set timing is out.	ON: Auto ; OFF: Normal
	Exit				

Note : After configuration is set, RESET won't restore to default setting.



### Setting

Indicator	Meaning	Default	Adjustable range	Remark
	Volume	32	0~63	
	Mute	Off	On / Off	On : Mute , Off : Sound
	Mirror	Off	On / Off	Left-right reversal
	Flip	Off	On / Off	Upside down
	Language	English	English / 中文 / 日本語 / 한국의 / Française / Deutsch / Italiano / Española / Português	Reset won't restore to default setting
	Reset			Restore to default
	Exit			



Info.

MENU

Image

Source : HDMI

Function

Resolution : 1024x600

Setting

H-Position : 37.5KHz  
V-Position : 59.8Hz

Information

Program Ver : 1.00  
Command Ver : 1.00

Move Exit / Menu

Hot Key When OSD Menu is Off :

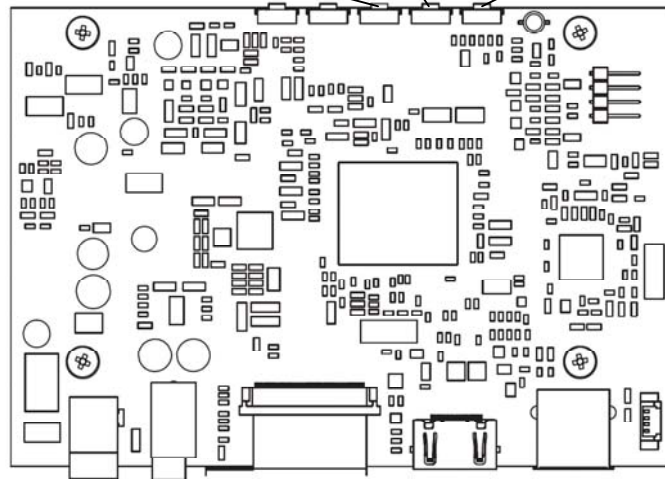
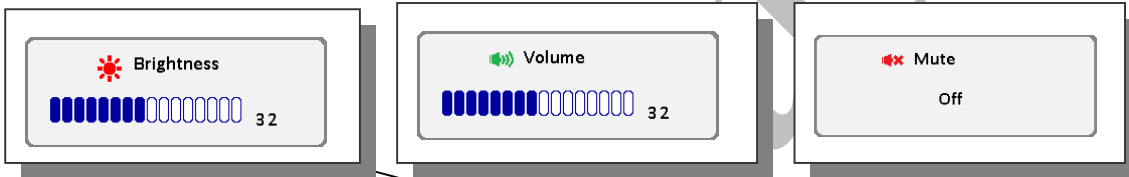

Information of Input Source and Functionality :

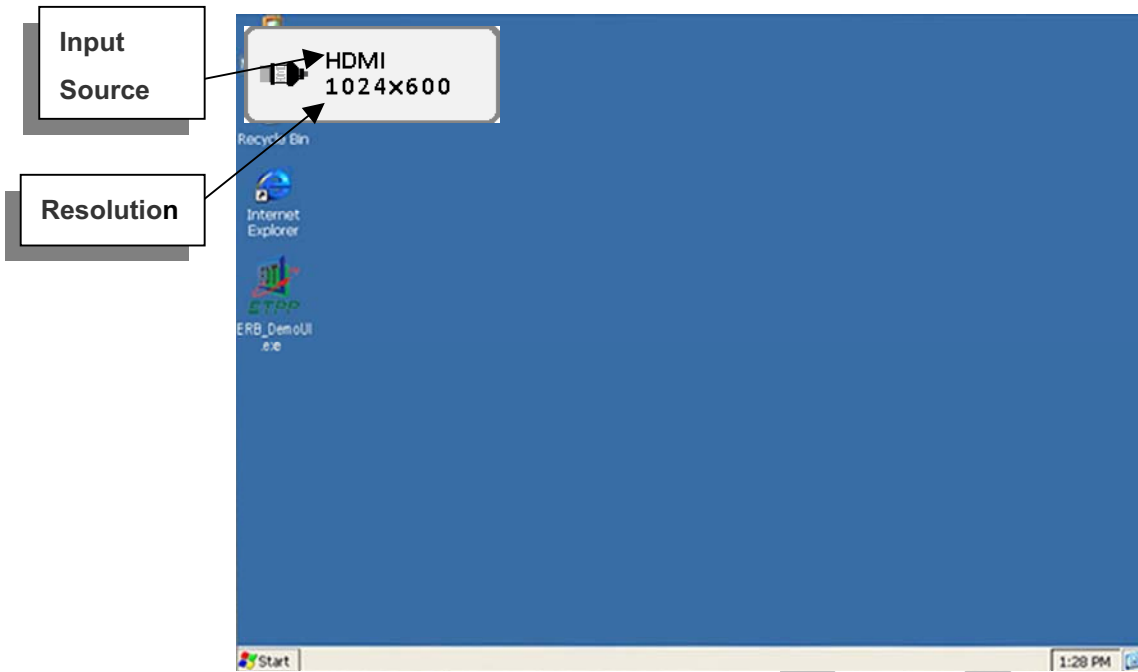

[Source] : Input Signal Switch

Overview of Input Signals :

Indicator	Interface
	HDMI

## 13. Dimension Information

### 13.1 Unit (LP070A065P-FNR)

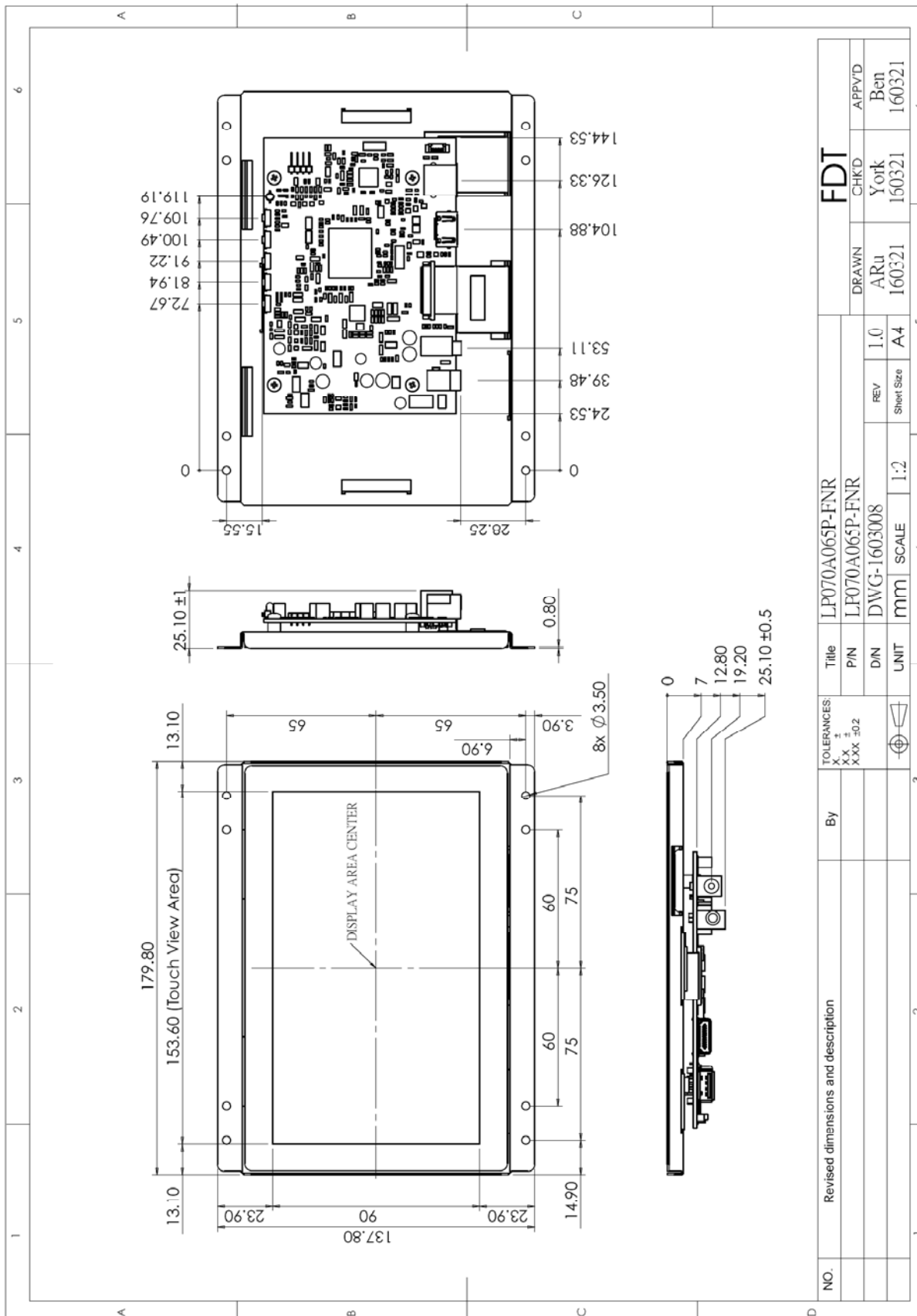





14. Appendix

14.1 TFT-LCD Mechanical Specifications

Parameter	Specifications	Unit
Screen Size	7 (diagonal)	Inch
Display Format	1024 x (R.G.B) x 600	Dot
Active Area	153.6(W) x 90.0(H)	mm
Pixel Pitch	0.15(H) x 0.15(V)	mm
Pixel Arrangement	RGB-stripe	
Surface Treatment	Clear	

14.2 TFT-LCD Optical Characteristics

Parameter	Symbol	Condition	Min	Typ	Max	Unit	Remark
Viewing Angle	Horizontal	Left	65	75	---	deg	
		Right	65	75	---	deg	
	Vertical	Top	60	70	---	deg	
		Bottom	65	75	---	deg	
Contrast Ratio	CR	At optimized Viewing angle	500	700	---	---	
Luminance	L		200	250	---	cd/m <sup>2</sup>	
LED Life Time		25°C	15000	---	---	Hrs	